



Bed Bugs AND Book Bags



SCHOOL ENRICHMENT CURRICULUM
FOR GRADES 3-5

Bed Bugs and Book Bags

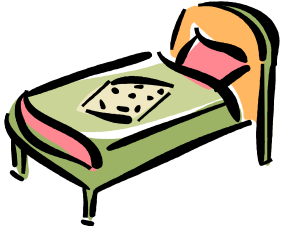

Teacher's Guide



University of Florida Cooperative Extension
Institute for Food and Agricultural Sciences

Credits and Acknowledgments

Bed Bugs and Book Bags was developed through the cooperative effort of the Duval County Extension Office and the Department of Entomology and Nematology at the Institute of Food and Agricultural Sciences, University of Florida.

The curriculum package was developed by Erin Harlow, Commercial Horticulture Extension Agent in Duval County, Dr. Rebecca Baldwin, Department of Entomology and Nematology, Corraine McNeill, Department of Entomology and Nematology, Dr. Phil Koehler, Department of Entomology and Nematology, and Jane Medley, Department of Entomology and Nematology with special assistance from Dr. Roberto Pereira, Department of Entomology and Nematology, Jennifer Leggett of Lindsey Pest Services, Jacksonville, and members of the Jacksonville Bed Bug Task Force. We would also like to thank Dr. John Capinera, Joy, Jordan, Tracy Tesdall and Peggy McNeill for providing suggestions to earlier drafts of this document.

Cooperative Extension Service, University of Florida, Institute of Food and Agricultural Sciences, Millie Ferrer-Chancey, Interim Dean, in cooperation with the United States Department of Agriculture, publishes this information to further the purpose of the May 8 and June 30, 1914 Acts of Congress, and is authorized to provide research, educational information and other services only to individuals and institutions that function with non-discrimination with respect to race, creed, color, religion, age, disability, sexual orientation, marital status, national origin, political opinions, or affiliations.

Table of Contents

Introduction

Credits and Acknowledgments

Bed Bugs and Book Bagsv

Learning Concepts.....vi

Lessons and Activities by Subject—Learning Conceptvii

Curriculum Componentsviii

The Experiential Process: Steps and Techniquesix

A Closer Look at the 4-H Learning Modelx

Bed Bug Background (Teacher's Guide)1-12

Lesson 1: Bed Bug Banquet (Feeding)

1.1 Hygiene and Health13-15

1.2 Eat Like a Bug16-27

Lesson 2: Bed Bug Barracks and Beyond (Habitat, Growth and Development)

2.1 Bed Bug International28-36

2.2 Bed Bug Biology37-50

Lesson 3: Bust the Bed Bug (Prevention, Detection, and Control)

3.1 Bed Bug Game51-63

3.2 Starring Bed Bugs64-66

3.3 Feelings Finder67-69

3.4 Healthy Hands have Healthy Homes70-72

3.5 High Tech Bed Bugs73-75

3.6 It's Getting Hot in Here!76-88

Appendices

A. Sunshine State Standards and Benchmarks89-97

B. Teacher Feedback Form98

Bed Bugs and Book Bags

Introduction

Bed bugs are real! Common bed bugs are tiny, parasitic insects that have been around for many centuries. They feed preferentially on human blood but are also known to obtain blood meals from bats, poultry, pets (dogs, cats, birds, rabbits, rodents), livestock and laboratory animals. They can be found in all 50 states of the U.S. and in many other countries. Within the past few years, bed bugs infestations have dramatically increased and have created major concern for society and for pest management professionals. They are thought to be the most difficult and expensive insect pests to control in the United States. Anyone, at anytime, anywhere can come in contact with bed bugs. By being aware of signs of infestation in our daily activities, we all can play our part to prevent spreading these pests. *Bed Bugs and Book Bags* was designed to raise awareness among students about bed bug infestations and what they can do to help prevent the spread of bed bugs.

Purpose of the Curriculum

The curriculum is designed to provide hands-on activities to increase students' understanding and awareness of bed bugs. It was designed with the intent to help students become more familiar with bed bugs, empower students to take control of their health, and understand what they can do in the event they get bed bugs.

Using the Curriculum

Bed Bugs and Book Bags is a school enrichment curriculum that targets grades 3-5. Both group and individual activities encourage participation and action in all aspects of this program. Teachers are encouraged to select learning activities that are most suitable to their students, as some activities may be more appropriate for some audiences than others. Sunshine State Standards have been assigned to each activity for health educators.

Bed Bugs and Book Bags is organized so that educators can either use the activities together as an entire unit, or independently to supplement other curricula. The activities are ready-to-use and easy to implement without having to assemble hard-to-find materials. All the reference sheets, activity sheets, games, and background information necessary to complete the activities are included in the guide.

Bed Bugs and Book Bags is activity-based and uses the experiential learning model to help students better internalize the information presented and apply it to their lives. It focuses on helping students develop life skills as well as the subject matter skills. In addition, the curriculum is interdisciplinary and has activities that can be used in science, language arts, health, art, and geography.

Learning Concepts

Self Concept:

Students being empowered by learning that they have some control over their bodies and the health of their bodies.

Hygiene and Health:

Students become aware that personal hygiene is a part of staying healthy and confident.



Critical Thinking:

Students problem-solve to focus on deciding what to do in a situation concerning bed bug infestations.

Critical Understanding:

Students value diversity in health across cultures.



Environmental Understanding:

Students begin to understand that there is a relationship between the environment and themselves.

Communication:

Students begin to understand language associated with bed bugs and personal hygiene and to relate their experiences through expression.

Creativity:

Through their imagination, students express their ideas, thoughts, and fears associated with their experience of bed bug infestations.



Social Development:

Students begin to understand that their role and that of their parents/caregivers in the control and prevention of bed bug infestations.

Technology:

Students participate in exploring, designing, and creating ways to control and help prevent bed bugs.



Curriculum Components

Teacher Guide:

A Teacher's Guide is provided at the beginning of the lessons with references back to important sections listed in each activity. It is recommended that the teachers/leaders become familiar with the entire teacher's guide to help prompt student questions.

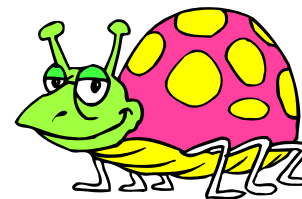

Lesson Introduction with Background Basics:

Each of the three lessons begin with an introduction that provides background information for the teacher and helps to organize the activities for the participants. The background information provided addresses the important concepts and vocabulary covered in the lesson activities. With this information, the teacher can use the lesson as a unit of study or select activities to supplement other curricula. The lesson activities can be adapted and conducted according to the needs of the participants and time frame devoted to this project. The references and citations used for each lesson are listed at the end of each activity.

Lesson Activities:

LEARNING CONCEPTS:

- Communication
- Health and Physical

GRADE LEVEL: 3-5

SUBJECT: Health, Science

SETTING: Indoors; classroom with desks or tables

TIME NEEDED: 30-45 minutes

LIFE SKILL: Students learn how to take good care of themselves

SUNSHINE STATE STANDARDS:

HE.3.C.1.1, HE.3.P.1.2
HE.4.C.1.1, HE.4.P.1.3
HE.5.C.1.1, HE.5.P.1.3

MATERIALS NEEDED:

Copy of activity sheet for each student

VOCABULARY:

Ectoparasite, harborage

TEACHER REVIEW:

Section 1.1

Section 1.6 - 1.9

The activities provided in each lesson are specifically designed to guide the learner through targeted concepts related to the lesson topic. The activities provide variety and include creative projects, games, and other activities to make learning about bed bugs both fun and educational.

Activities are separated with their own sidebar (Figure 1) that provides a quick overview of the activity's learning concept, suggested grade level and specific classroom subject. Key concepts and objectives for each activity are listed, along with a materials list and a summary of any advance preparation needed by the leader.

The activity sidebar (Figure 1) summarizes the main learning concept of the activity, the time needed, setting descriptions, applicable Sunshine State Standards, the project and life skills targeted, vocabulary (if needed), and the teacher review sections.

Each activity provides an introduction for the participants, and a "Do" section. The activity then concludes with discussion questions and suggestions for students to "Reflect" and "Apply" the knowledge and skills they have gained.

The variety of activities for each lesson topic provides the teacher with choices depending upon the resources, environment for teaching, or interests of students. You may choose to complete one or more of these activities during the unit of study or as a "project series".

Appendices: Contains additional resources to help educators facilitate the curriculum. Included is a glossary and a complete description of the Sunshine State Standards used in the activities.

Figure 1. Activity side bar

The Experiential Learning Process

Steps and Techniques

The activities in each project lesson strive to involve young people in experiences that require them to interact, analyze, question, reflect, and transfer what they have learned to personal application. The activity comes first, and the “learning” comes from the “discovery” of new knowledge and skills as a result of the experience. However, to end with the experience without building upon it through REFLECTING and APPLYING does not help the young person understand the significance of what he/she saw, heard, or did. It is the transfer of this significance from one experience to another that helps young people apply their “learning” in future situations.

A further description of the steps in the process may be helpful as you become an active participant in the *Bed Bugs and Book Bags* program.

Experience. Begin with concrete experience. This can be an individual activity or a group experience, but it involves “doing something”. The learning experience will most likely take place when the experience is unfamiliar or a first-time activity for the learner, pushes the learner beyond any previous performance levels, is uncomfortable, and includes the risk of failure.

Share. Next, get the participant(s) to talk about the experience. Show reactions and observations. Let the group talk freely. Acknowledge ideas; listing them visually is helpful. Allow time for volunteers to share responses. Encourage group members to answer questions posed by others. As the leader/teacher, allow students to answer the questions.

Process. Discuss how themes, problems and issues are brought out by the exercise. Speak to specific problems and issues that the group discovers from the exercise or recalls from personal experiences. Look for recurring themes and write them on newsprint or chalkboards. Have small groups discuss and report back, have a panel discussion, or generate ideas individually on 3”X5” cards.

Generalize. Find general trends or common truths in the experience. Draw out and identify the principles that are important and that apply to “real life,” not just the activity. This focuses on the key messages. List key terms that capture the lessons. Identify situations where the principles apply.

Apply. Concentrate on how the new learning can be applied to everyday situations. Discuss how issues raised by the activity can be useful in the future. Describe how more effective behaviors can grow out of what is learned. Write personal goals for behavior changes, take turns solving problem situations in groups of two or three, or role-play situations that show how new behavior is learned. Each individual should feel a sense of ownership for what is learned.

Let's Do:

Each lesson topic identifies the activity or series of activities to DO involving students in a common EXPERIENCE.

Let's Reflect:

At the conclusion of the activity, allow time for the students to REFLECT (share and process) what they learned from the experience. Each lesson guide outlines some key questions to assist you in this process.

Let's Apply:

Help students to APPLY their new knowledge and skill to real-life situations. You can do this by helping them to identify key principles that are important for future decisions or personal action. Again, each lesson has outlined a few questions to direct this process.

A Closer Look at the 4-H Experiential Learning Model

This five-step model is used throughout the activities in this unit. All activities support the experiential learning model. Each activity lists the learning concept to be practiced.

Techniques

Use a Variety of Experiences

The activities in *Bed Bugs and Book Bags* have been designed to provide a variety of choices for your use. Consider choosing various kinds of activities to engage different learning styles throughout your study of bed bugs.

Develop Questions to Ask

The types of questions asked will vary with the activity. Some questions may relate to the content, but should go beyond it. If a specific learning concept is to be enhanced, then the students should have the opportunity to become as involved with understanding the life skill as they are in understanding the subject-related skill. Each activity in this project unit has identified questions for this stage of discussion. The more you ask additional thought-provoking questions and help them clarify and expand on their ideas, the richer the students's educational experience will be. However, questions to help move in this direction:

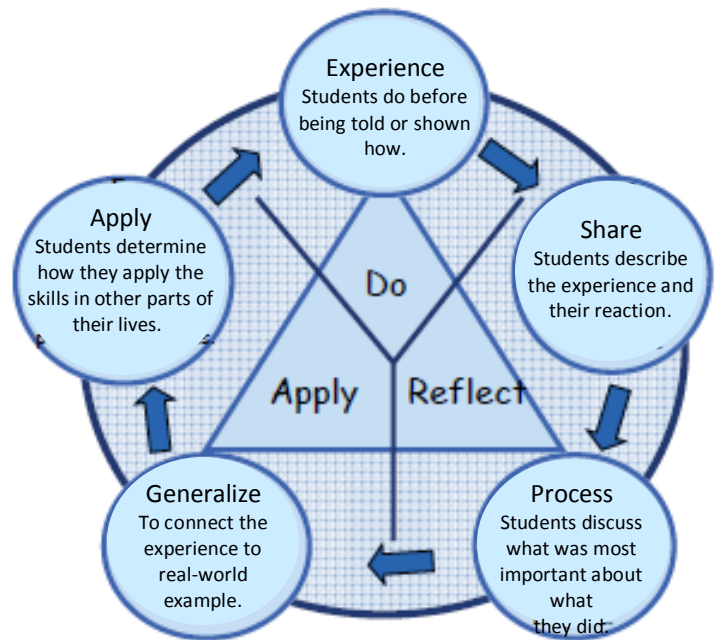

1 Sharing Questions

- What did you do?
- What happened?
- How did you feel?
- How did it feel to...?
- What was most difficult? Easiest?

2 Processing Questions (Use data generated from sharing questions)

- What problems or issues seemed to occur over and over?
- What similar experiences have you had?

3 Generalizing Questions

- What did you learn about yourself through this activity?
- What did you learn about (life skills, eg. making decisions)?
- How do the major themes or ideas relate to real life and not just the activity?
- How did you go about making your decision?

4 Applying Questions

- How can you apply what you learned (making decisions) to a new situation?
- How will the issues raised by this activity be used in the future?
- How will you act differently in the future as a result of this activity?

Section 1.1 Introduction

Bed bugs are real! Common bed bugs are tiny, parasitic insects that have been around for many centuries. They feed preferentially on human blood but are also known to obtain blood meals from bats, poultry, pets (dogs, cats, birds, rabbits, rodents), livestock and laboratory animals. They can be found in all 50 states of the U.S. and in many other countries. Within the past few years, bed bug infestations have dramatically increased and have created major concern for society and for pest management professionals. They are thought to be the most difficult and expensive insect pests to control in the United States. Anyone, at anytime, or anywhere can come in contact with bed bugs. By being aware of signs of infestation in our daily activities, we all can play our part to prevent spreading these pests.

Section 1.2 History

Some scientists believe that bedbugs originally fed on the blood of bats and birds but then switched to feeding on humans (*Homo sapiens*) who lived in caves. Some of the earliest records of bed bugs date back to the ancient Greek and Roman Empires. Peoples who built the very first homes along riverbanks came from hills and caves and brought with them blankets and clothing – bedbugs came as well. Bed bugs were usually found in the small cracks in the walls and very soon infestations increased. As the Roman civilization grew (new cities created, increasing demand for luxury items such as fine fabrics, modern beds, chairs and furniture), more items were brought into Rome from around the world. Bed bugs hid in dark corners of ships and between the folds of fabrics, eventually making their way into the homes of citizens – both rich and poor alike.

During the 18th century as European explorers sailed and colonized areas of the New World (Americas), ships were known to house bed bugs. Bed bugs were also spread as people travelled around the countryside by horse and carriage and then by train when railways were invented. As city living conditions increased, bed bug populations increased. During the 1940s and WWII, bed bugs were a consistent nuisance.

Learning Lessons

1) Bed Bug Banquet (Feeding)

2) Bed Bug Barracks, and Beyond (Habitat, Growth and Development)

3) Bust the bed bug! (Prevention, Detection and Management)

Key Point: Bed bugs are major pests today. Knowing about them will help control their spread and harm.

Objectives:

- How do bed bugs compare to other animals and to humans?
- What changes do bed bugs undergo as they grow from immature to adults?
- Which habitats are suitable for bed bug growth and development?
- What biological factors place bed bugs in the pest category?
- Should they be considered a public health pest?
- How can bed bug infestations be prevented at home and school?

Lesson time: Lesson time will be varied depending on activities. Select the activities that are most appropriate for your age group and situation. Most lessons should take between 30 – 45 minutes.

Advance preparation:

- a) Review Teacher Enrichment.
- b) Review the various activities and determine which are suitable for your age group and situation.
- c) Collect all materials needed to carry out the selected activities.

Up until this time, many things had been used to try and control bed bugs: cups with oil under each foot of beds, kerosene, pyrethrum dust, and by then, DDT, the most famous insecticide of all time. Many of these worked, especially DDT, which affected the nervous system of the insect. However, DDT has since been banned, but at that time bed bugs were becoming resistant to DDT. Many other chemicals have been used historically to control bed bug populations (organochlorines, carbamates including malathion).

Until just a few years ago, bed bug populations were under control. However, a rampant resurgence has occurred. Possible causes include: 1) Travelling has become much more affordable and many people are travelling more places than ever before; 2) People (students and working class people alike) in an effort to save money, have been reusing discarded furniture found by dumpsters, and old mattresses are being reused; 3) Many people haven't seen bed bugs in a long time or may not even know about them, which means they don't recognize signs of infestation. Even doctors will mistake bed bug bites for mosquito bites, chigger bites, scabies, chicken pox or skin rashes; 4) Even if infestations are present, people do not have the money or time to properly take care of the situation so populations spread; and 5) Bedbugs are resistant to many chemical pesticides, so populations are not easily controlled.

Section 1.3 Bed Bug Biology

The Linnaeus system of classification characterizes bed bugs as belonging to:

Kingdom: Animalia (animals)

Phylum: Arthropoda (arthropods)

Class: Insecta (insects)

Order: Hemiptera (true bugs)

Family: Cimicidae (bed bugs)

Genus: *Cimex*

Species: *lectularius*

Scientific name: *Cimex lectularius* Linnaeus

Name: Common Bed bug



Bed bug adult



Bed bug nymph
with and without

Section 1.4 Describing Bed Bugs

Adult bed bugs are flattened, oval-shaped bugs with small, yellowish hairs all over the body. Bed bugs have reduced, non-functional wings (wing pads) so they cannot fly or jump, but they can move very quickly across horizontal and vertical surfaces. They are approximately 5 mm long and 3 mm wide (approximately the size of an apple seed).



Body: The **head** (anterior section) of a bed bug has two four-segmented antenna, a three-segmented piercing-sucking mouthpart (proboscis) which lies in a ventral groove, two compound eyes but no simple eyes (ocelli) to detect light. The **thorax** (middle section) of the bed bug contains all six legs and the reduced wings (wing pads). Bed bugs DO NOT have functional wings.

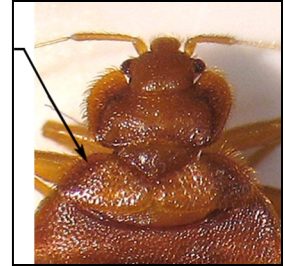

The **abdomen** (posterior section) houses the digestive and reproductive system. The tip of the abdomen is more pointed on male bed bugs and is more rounded on female bed bugs.

Color: The color of adult bed bugs ranges from brown to reddish-brown. After feeding the body of the bed bug swells and turns red. Bed bug eggs are shiny and milky-white and measure approximately 1 mm. They are elongated and slightly bowed. Immature bed bugs are called nymphs and are translucent after hatching and measure about 1 mm. They also turn red after feeding.

Section 1.5 Bed Bug Feeding

Bed bugs are ectoparasites, meaning that they feed on the outside of the host's body. They feed only on blood. They prefer to feed on humans, but will also feed on a variety of other hosts such as poultry, dogs, cats, bats, and rodents such as rabbits, hamsters, gerbils and ferrets. Bed bugs feed about once a week. Feeding occurs mostly after midnight and until dawn. Bed bugs can feed for about 10 minutes. When bed bugs are not feeding on a host, they spend their time hiding in dark, protective places such as cracks in walls, under beds, behind furniture, etc. Immature bed bugs need to feed on blood so they can grow to the next stage (molting). Adult female bed bugs need blood not only for nourishment, but also to be able to produce eggs. Male bed bugs also require blood meals for sperm production. A bed bug can typically consume 8 mg of blood at a time. Temperature affects how often bed bugs feed. Bed bugs feed best at higher temperatures. They have been found feeding aggressively as low as 44°F, but the ideal feeding temperature is about 80°F.



Sometimes a blood meal for a bed bug is hard to find (e.g. homes vacated for winter holidays), but they can starve and survive for long periods of time. Mature nymphs and adult bed bugs can survive much longer than newly hatched nymphs. For example, after the 3rd nymphal stage, bed bugs can survive for over 400 days at 50 °F compared with 1st stage nymphs that can survive for 275 days without food. At higher temperatures, (e.g., 80 °F), bed bug survival for nymphs and adults is about 1/10 as long.

Section 1.6 How Does a Bed Bug Find its Host?

There are seemingly 3 stages to bed bug host finding.

- **Random searching phase:** The bed bug wanders about with antennae outstretched because it is hungry.

- **Orientation:** Bed bug locates environmental cues (e.g., carbon dioxide, heat or human body odor) and moves towards them.
- **Test and feed:** The bed bug is on the host and tests various sites on the host until it finds a suitable area for inserting its mouthpart (beak).

Section 1.7 How Does a Bed Bug Feed?



- It grips the host with its foreleg claws.
- It inserts its proboscis (mouthpart) into the skin and moves its body back and forth to penetrate deeper.
- The cutting/slicing action of the beak tears through tissue until a blood vessel is located (the bite is usually painless but can leave an itchy spot or cause welts on skin).



Before feeding

After feeding

- The blood vessel is punctured and blood flows into the digestive system of the bed bug. The bed bug swells and changes color.
- Feeding is complete when the bed bug releases a small drop of blood from its anus. (These are brown spots seen within infested areas).

A row of bites is often seen when bed bugs have fed. This row of bites occurs if: a) the person shifts while the bed bug is feeding so the bed bug has to stop feeding and find another site to puncture; or b) multiple bed bugs are feeding simultaneously.

Many times, people who have been bitten by bed bugs are afraid to sleep in their beds or sit on their couches. Sometimes people who suspect that they have bed bugs can get quite paranoid – they feel like they have been bitten even though they have not. This is called **delusory parasitosis**. It should be noted, though, that people who are bitten by bed bugs can get a secondary infection. When bed bugs feed, they are not known to transmit any diseases. You CANNOT get mumps, chicken pox or the flu from bed bugs. Sometimes there is a delay in the reaction caused by bed bug bites which means that you may not see any signs that you have been bitten until days or weeks later.

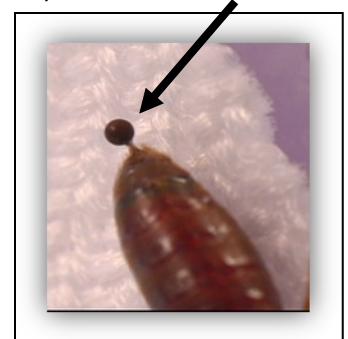

Section 1.8 What Feeds on Bed Bugs? (Bed bug natural enemies)

There are several organisms that are known to feed on bed bugs! Organisms that feed on bed bugs are called the natural enemies of bed bugs. These natural enemies include insects, spiders and other arthropods. The pie chart below gives an idea of these natural enemies.

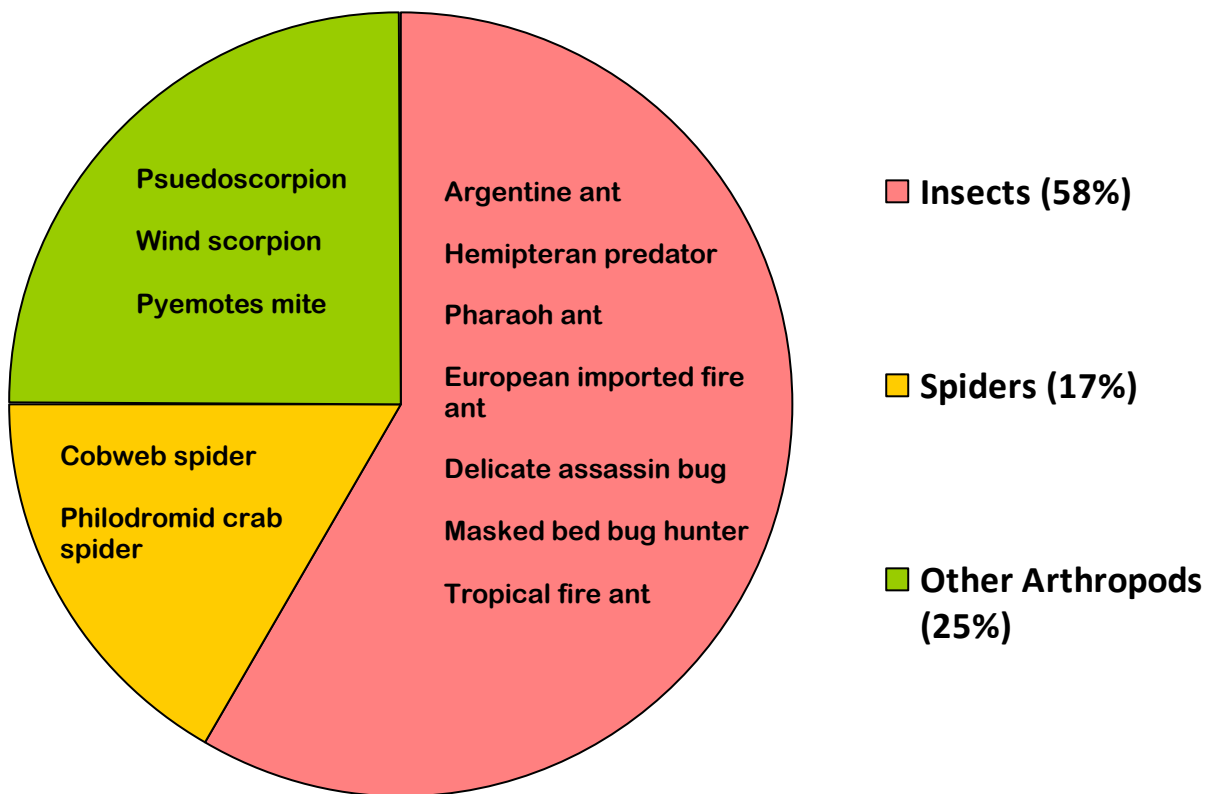

Section 1.9 Bed Bug Growth and Development

Once a female bed bug has had a blood meal and mated, it is time for her to lay eggs. She may lay about three eggs per day. Eggs are laid on their side and are coated with a sticky substance which helps to adhere them to the surface on which they are laid. Once the eggs hatch, there are five immature (nymph) stages and then the adult. Bed bugs undergo simple metamorphosis, which means that as they undergo molting, the immatures will look similar to the adults except that they lack reproductive structures and wing pads.

The following bed bug life cycle gives an indication of how growth and development happens:

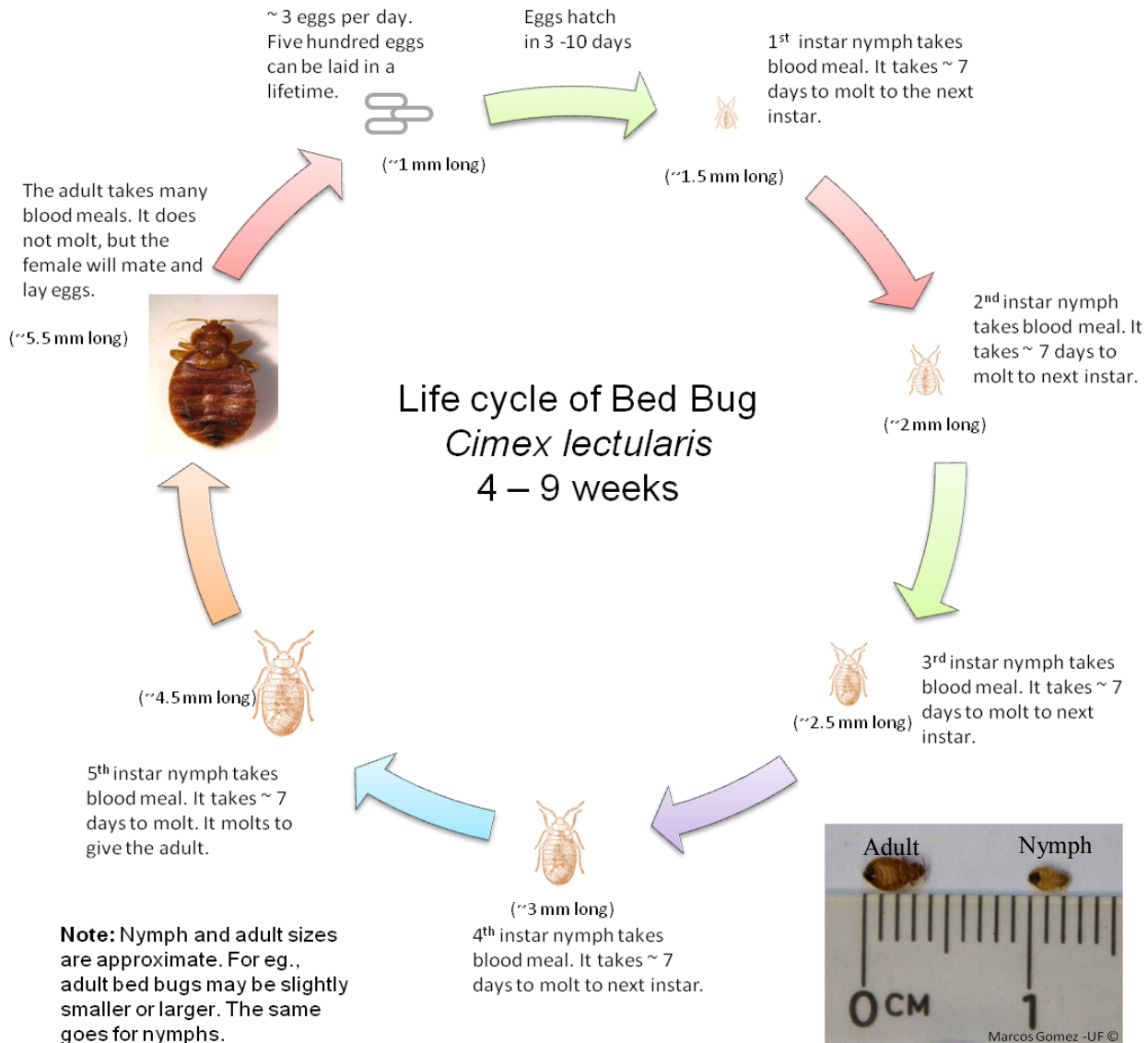

Bed bugs die if they are exposed to 120°F for 1 minute or 113°F for 30 minutes, but they can live for 5 days in the freezer.

Section 1.10 Bed Bug Habitats and Habits

Bed bugs can be found in many areas! Some of the common areas include homes, schools, campers, laundromats, hotels, residence halls, churches, movie theaters, prisons, hospitals, offices, airports/airplanes, used furniture and clothing stores, and anywhere else that people go regularly!

How bed bugs get to all these areas is an example of how easily they can be spread.

- 1) Bed bugs are excellent hitchhikers! They are not limited to beds. They get carried to new places by being in infested clothing, bags - anyone's belongings.
- 2) Also, they actively migrate. They can walk up walls, down curtains, across ceiling and floors and along furniture edges. They can also move through connected buildings by crawling through cracks in walls, pipe ways, vents or electrical wiring spaces or even going outside through windows – and all without the aid of human transport. Immature bed bugs can walk almost 1 foot/minute, whereas adult bed bugs can crawl more than 4 feet/minute.

Bed bugs like to spend most of their time hiding in dark, undisturbed areas. They also tend to clump together to protect themselves from predators. They will leave these aggregations when hungry; they return once they have fed. Within a certain area, bed bugs have places that they can hide. These are called harborage. Below are some pictures of different harborage where bed bugs can be found.

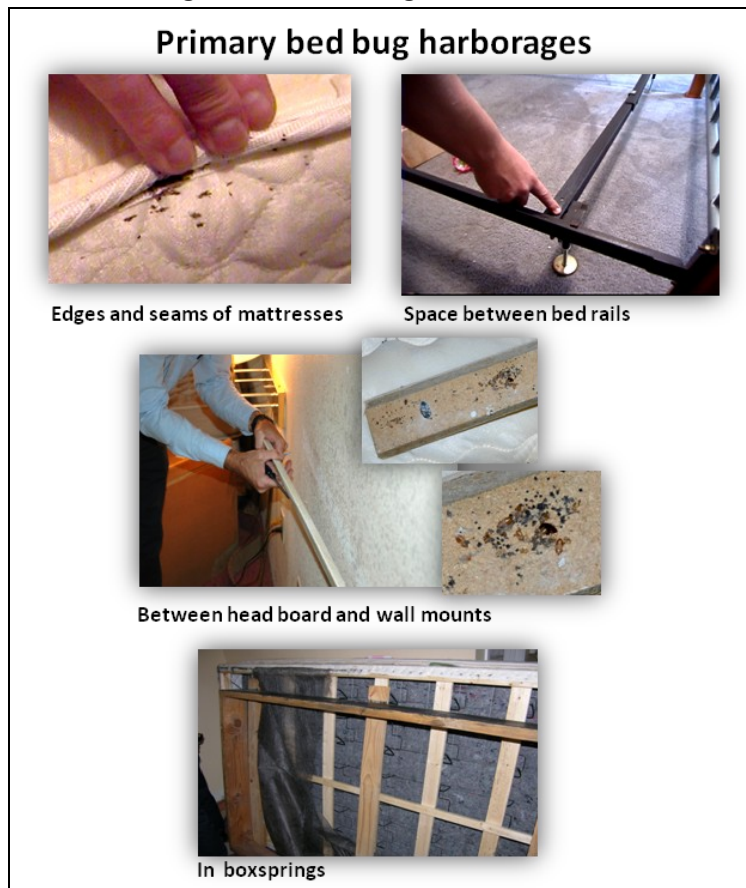

Secondary bed bug harborages



Corners of nightstands and dressers



Tables and chairs



Corners of baseboards



Behind picture frames



Under carpets

Other potential bed bug harborages



Smoke Detectors

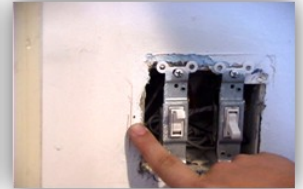

Wall outlets



Along popcorn ceilings

Other bed bugs sites can include but are not limited to:

- Closets, light fixtures, books
- Pet cages/beds, computers, stereo components
- Clutter of any kind, stuffed toys
- Laundry baskets, telephones
- Loose wallpaper, door frames
- Under chipped paint, just about anywhere!

Some insects will look very similar to bed bugs. One such example includes immature German cockroaches (as pictured below). It is good to know the differences between bed bugs and other bugs so that you can take appropriate management strategies.



Section 1.11 Recognizing Signs of a Bed Bug Infestation



- **Blood smears, fecal spots, eggs or shed skins:** These are the most noticeable signs of bed bug infestation. *Fecal spots* are black or rust-colored spots found on the mattresses, sheets, pillows, and box springs. They are caused by bed bug defecation after feeding. *Blood smears* are different. Smears are the red blood stains that occur when a bed bug is squashed while it still had an undigested blood meal in its gut.

- **Bites:** Bed bug bites are usually seen on the arms, legs, or on the backs of individuals. They are usually raised pink or red bumps on skin. These bites are painless at the time of feeding. Some people have no reaction to the bites. Others are itchy afterward, and yet others can have severe reactions that result in boils on the skin. Bed bug bites are often confused with bites from mosquitoes or chiggers. Most times the bites will be seen as rows of spots.
- **Odor:** When there are heavy infestations of bed bugs, a sweet pungent odor is noticed. This is due to the secretions that bed bugs make after feeding. In fact, bed bugs have such a unique odor that dogs can detect individual bed bugs or bed bug eggs! Many hotels use bed bug-sniffing dogs to identify infestations.



Section 1.12 Infestation versus Introduction of Bed Bugs

It is very important to know the difference between an infestation of bed bugs versus an introduction of bed bugs. An **infestation** of bed bugs is a reproducing population, i.e. when all stages of bed bugs (eggs, various nymph stages and adults) are found in a given environment. An **introduction** of bed bugs is described as the transportation of bed bugs (e.g., in clothing, luggage, furniture) into an uninfested area. An apartment or home with blood smears and fecal spotting, along with visible bed bugs, would be called an infestation. If someone brings bed bugs into an area not previously known to have bed bugs, that would be called an introduction.

Section 1.13 Preventing and Reducing Bed Bug Infestations at Home and School

- Make sure you know what a bed bug looks like, or know their signs of infestation, so that you can act accordingly. An inexpensive magnifying glass and flashlight found at discount stores can help you be able to see or find bed bugs more easily.

- DO NOT take home couches, mattresses, beds or any other furniture that you find by the dumpster or which has been abandoned.
- Thoroughly inspect any furniture that you do bring into your home for signs of bed bug infestations, especially used furniture that may have come from thrift stores or garage sales.
- Wash and properly dry your clothing on high heat. Remove and launder all bed linens including pillows.
- Keep your mattress off the floor and away from the walls. Make sure that you clean behind your bed and behind other furniture in your room regularly. Regularly inspect your mattress, bed frames and box springs for signs of infestations.
- Avoid cluttering! Don't pile toys, clothes, books, etc., under the bed or on the floor in a corner. Help to keep your room clean. Clutter like this makes great harborages for bed bugs.
- Take precautions while you travel to other places. When travelling on public transportation, inspect the seat where you will sit. Check your luggage/bags/coats carefully before going home after a visit to another location. Cycle your clothes in a clothes dryer on high heat right after you get home.



- Implement small preventative measures such as using **climb up traps** (pictured to the left) under the foot of your bed to prevent bed bugs from climbing up into your bed. The foot of the bed goes in the central area.
- Make sure that all cracks and crevices around the home are fixed and sealed and that holes are repaired.
- If you do think you have seen/found a bed bug, children should alert their parents/guardians. Parents/guardians should contact a licensed pest control operator or your county extension office. These professionals know how to handle bed bug infestations. They will evaluate the situation and carry out a thorough inspection. Also discard or heat treat any item in your home that is potentially infested.
- If anyone reports having bed bug problems close to where you live, do not take their situation lightly. Encourage them to contact the appropriate pest control authority or their housing office as appropriate. Visits to their homes should be avoided if bed bugs are suspected. If someone that you suspect of having bed bugs comes into your home, have them put their belongings (purse, coat, bag etc.) in sealed containers so that bed bugs are not transferred.
- At school, students should avoid sharing coats/jackets/hats with other students.

- Students should make sure to check lockers or their desks carefully before putting their books or bags in.
- Students should make sure that they wear clean clothes to school, not ones that have been sitting in a dirty pile at home.
- **Section 1.14 What to do if you recognize signs of bed bugs at home or school?**
- ***If children are at school*** and they recognize bed bug signs in the classroom or anywhere on campus, they should alert a teacher/adult immediately.
- If children happen to see bed bugs in another student's belongings, they should alert an adult/teacher immediately. Children should be aware that bed bugs can be picked up anywhere and may not have come from that child's home. Teachers will then make sure that the proper procedures are carried out.
- ***If children are at home*** and they recognize signs of bed bugs they should alert their parents/guardian immediately. The informed adults should then put all clothing including book bags and shoes in garbage bags for laundering. These items should then be heat treated by putting them in the dryer for one hour. Make sure to put freshly laundered and heat treated items in a clean garbage bag; do NOT reuse the one that they were in originally. Bagging items will help to prevent the spread of the infestation. The rooms in the house should also be vacuumed. Mattresses and box springs should be put in special cloth encasements such as those by Protect-A-Bed or Mattress Safe. Climb up traps should be put under the foot of beds. Parents should call pest services immediately.



Section 1.15 Take home points

- 2) Beds bugs are real; bed bugs are back!
- 2) Anyone can have bedbugs! Bed bugs like people of all ages and all cultures.
- 3) Know bed bug biology.
- 4) Recognize signs of infestation so that you can act appropriately!
- 5) If you recognize that there are bed bugs present on someone or in your home, tell your teacher or your parent/guardian immediately!
- 6) Be proactive -Do your part to keep bed bugs from spreading (reduce clutter, clean your room).

References

Bed Bugs Handbook. (2010). Retrieved from <http://www.bed-bugs-handbook.com/bed-bugs-bite.html>

Brooks, S. E. (2010). *Featured Creatures: Bed Bug*. Retrieved from University of Florida Featured Creatures Web site http://entnemdept.ifas.ufl.edu/creatures/urban/bed_bug.htm

Florida Center for Instructional Technology. (2009). *Bed Bug Clipart*. Retrieved from http://etc.usf.edu/clipart/59200/59237/59237_bedbug.htm

Cooper, R. (2011). *Bed Bugs 101*. Retrieved from http://www.bedbugcentral.com/bed_bugs_101.pdf

IFAS at the University of Florida (2011). *National School IPM Information Source: Bed Bugs in Schools*. Retrieved from <http://schoolipm.ifas.ufl.edu/Florida/bedbugpests.htm>

Koehler, P. G., W. H. Kern, Jr., and R. Pereira. 2008. *General Household Pest Control SM-47* 2nd ed. Florida Cooperative Extension Service. Institute of Food and Agricultural Sciences.

Maestre, R. (2011). *The Bed Bug Book: The complete guide to prevention and extermination*. (1st ed.). New York: Skyhorse Publishing.

Michigan Bed Bug Working Group. (2010). *Bed bugs: What Schools Need to Know*. Retrieved from: http://www.michigan.gov/documents/emergingdiseases/Bed_bugs_schools_293498_7.pdf

Miller, D. M. (2010). *Bed Bug Prevention Methods*. Retrieved from: <http://www.vdacs.virginia.gov/pesticides/pdf/files/bb-prevention1.pdf>

Pinto, L.J., Cooper, R. and Kraft, S. K. (2007). *The Bed Bug Handbook: The Complete Guide to Bed Bugs and their Control*. (1st ed.). Maryland: Pinto and Associates, Inc.

For additional information contact your County Extension Office.

Hygiene and Health

KEY CONCEPTS:

- Children become aware that personal hygiene is a part of staying healthy and confident.
- Children begin to understand language associated with bedbugs and personal hygiene and to relate to their experiences through expression.

OBJECTIVES:

Students will be able to:

- Understand why hygiene is important especially as it relates to bed bugs
- Differentiate between preventing vs. eliminating bed bug infestations
- Recognize and recall the language associated with bed bugs and personal hygiene

ACTIVITY INTRODUCTION:

For this activity, students will have ample opportunity to talk with their teacher and express their views on how to take proper care of themselves and their environment so that they can help prevent or eliminate bed bugs. Ask questions such as: *What are bed bugs? Who has ever seen a bed bug? Are bed bugs insects? Where do you find bed bugs? What do bed bugs eat? What don't bed bugs eat? Do bed bugs make you sick? Where can you find bed bugs?* Encourage students to speak up. Encourage students to talk in groups where possible.

Let's Do:

Have students play the "Bed Bug Lingo" word search game. Copy and use the activity provided. Make sure that the words present in the word search game are used in the following classroom discussions.

Discuss the vocabulary words and discuss the difference between preventing and eliminating bed bugs.



LEARNING CONCEPTS:

- Communication
- Health and Physical

GRADE LEVEL: 3-5

SUBJECT: Health, Science

SETTING: Indoors; classroom with desks or tables

TIME NEEDED: 30-45 minutes

LIFE SKILL: Students learn how to take good care of themselves

SUNSHINE STATE STANDARDS:

HE.3.C.1.1, HE.3.P.1.2
HE.4.C.1.1, HE.4.P.1.3
HE.5.C.1.1, HE.5.P.1.3

MATERIALS NEEDED:

Copy of activity sheet for each student

VOCABULARY:

Ectoparasite, harborage

TEACHER REVIEW:

Section 1.1
Section 1.10
Section 1.11
Section 1.12
Section 1.13
Section 1.14

Let's Reflect:

Brainstorm ideas with students about personal hygiene as it relates to bed bugs. (For example: washing hands, laundering bedding regularly, wearing clean clothes, checking for bed bug bites, showering regularly, check your book bags, cubbies, desks, drying your jackets and shoes, and not sharing hats or jackets).

Why is personal hygiene important?

When should you check for bed bugs? Talk about creating a routine such as looking for bites after they brush their teeth in the morning.

There are many specific words that describe what bed bugs are or how they act. Some of these include the terms “arthropods”, “smears”, “ectoparasite”, “harborage”, “fecal matter”. Take some time to go to the dictionary or the internet and find out what these words mean. After discovering the meaning, use these words in a sentence to describe bed bugs. E.g. Bed bugs are **ectoparasites** because they feed on the body surface of people and most times cause allergic reactions.

Let's Apply:

Why do you think the bed bug problem has come back?

What attitudes do you need to have when dealing with bed bugs?

Do you think every single bed bug will be gone if the problem is treated?

How does this affect your thinking about making sure these pests are kept under control?

Discuss how students might prevent bed bugs from entering their homes. For example: using sealed bins for friends' stuff, helping keep their rooms clean, knowing what a bed bug looks like, etc.

Discuss how students might help eliminate bed bugs if they had them at home. For example: tell an adult, use heat treatments such as dryers, vacuums, contact professional pest services.

Notes:

VOCABULARY:

Ectoparasite: Feeds on blood.

Harborage: Area that provide insects with places to live.

BED BUGS LINGO

DIRECTIONS: Find the bed bug words in the word puzzle below.

E S F I C F H S B U G S L J A
 G S E U N E E S H Y M E S R L
 A T D S A F M E U P V G T M Q
 R L B D S E E S D A M H F A R
 O U O L A E T S R I R Y Z N C
 B D L R O C R T T O N S N A L
 R A S A E O L T P A L G S G U
 A Q B S C O D O T E T T N E T
 H C N E M E D E E A O I K M T
 P I N R D S F P T P M J O E E
 E C T O P A R A S I T E S N R
 S G N I R P S X O B B R O T Z
 T C R A C K S K X A R O H T D
 S H E D Z O J K S G G E Y U R
 P A P A B D O M E N S N I K S

- | | |
|--------------|---------|
| Abdomen | Bed |
| Adults | Bite |
| Boxsprings | Cracks |
| Management | Fecal |
| Ectoparasite | Head |
| Feeding | Bugs |
| Infestation | Nymphs |
| Mattresses | Skins |
| Pest | Spots |
| Sleep | Travel |
| Thorax | Smears |
| Arthropods | Shed |
| Blood | Molt |
| Clutter | Insects |
| Harborage | Eggs |

30 of 30 words were placed into the puzzle

BED BUGS LINGO

DIRECTIONS: Find the bed bug words in the word puzzle below.



- | | |
|--------------|---------|
| Abdomen | Bed |
| Adults | Bite |
| Boxsprings | Cracks |
| Management | Fecal |
| Ectoparasite | Head |
| Feeding | Bugs |
| Infestation | Nymphs |
| Mattresses | Skins |
| Pest | Spots |
| Sleep | Travel |
| Thorax | Smears |
| Arthropods | Shed |
| Blood | Molt |
| Clutter | Insects |
| Harborage | Eggs |

30 of 30 words were placed into the puzzle

Eat Like a Bug

KEY CONCEPTS:

- Children problem solve to decide what to do in a situation concerning bed bug infestation.
- Children begin to understand that there is a relationship between the environment and themselves.

OBJECTIVES:

Students will be able to:

- Understand how insects adapt to their environment.
- Learn how an insect's mouthpart relates to its food source.
- Demonstrate how a bed bug would use mouthparts for consuming food.
- Understand how nutrition impacts the life cycle of a bed bug.
- Understand what bed bugs bites look like and that bed bugs do not transmit diseases.

ACTIVITY INTRODUCTION:

Insects have various mouthparts depending on their food source. Some insects have pliers-like mouthparts (grasshoppers, cockroaches, beetles), others have sponge-like mouthparts that can only feed on liquids (houseflies), yet others have siphon or straw-like mouthparts (butterflies and moths). Mosquitoes, fleas, and true bugs, including bed bugs, all have syringe-like mouthparts that pierce and suck fluids. A bed bug's favorite "fluid" is blood. Bed bugs do not feed on anything but blood. Bed bugs like blood especially from humans. However bed bugs will also take blood from other organisms such as pets, bats, livestock, poultry and various rodents.

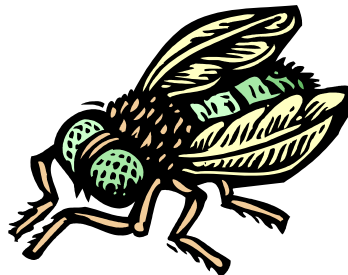

LEARNING CONCEPTS:

- Critical Thinking
- Environmental Understanding

GRADE LEVEL: 3-5

SUBJECT: Health, Science

SETTING: Indoors; classroom with desks or tables

TIME NEEDED: 30-45 minutes

LIFE SKILL: Analysis of facts, critical thinking

SUNSHINE STATE STANDARDS

HE.3.C.1.4

HE.4.C.1.4

HE.5.C.1.4

MATERIALS NEEDED:

Several copies of activity sheet for each student

Juice boxes and straws for each student in class.

TEACHER REVIEW:

Section 1.1

Section 1.5

Section 1.6

Section 1.7

Let's Do:

- Have students list different fluids on which insects may feed (e.g., sap, blood, nectar, pre-digested protein or sugar - saliva digests it first, and then it is sucked up).
- Using the worksheet, students should match the different "mouthparts" to the different insects.
- Using juice boxes with straws have students hold the straw in their mouths and then try and "pierce" the juice box hole like a bed bug without using their hands.
- Explain that bed bugs can get blood from other places. What else can bed bugs feed on? Allow students to participate in the "What to feed Bernie?" worksheet.
- Have student do the Bed Bug Feeding Crossword **OR** Bed Bug Feeding Facts matching game and discuss the answers afterward.
- Use the activity sheet "*Bed Bugs Bite*" as a discussion starter for where and how bed bug bites would appear on a person. Also discuss if bed bugs transmit disease.

Let's Reflect:

What did you learn about a bed bug's mouthpart that you didn't know before? Do bed bugs actually "bite"?

If the bed bug had a different mouthpart, do you think it would be able to enjoy its favorite food as much? Why or Why not?

Why would a chewing mouthpart or a sponge mouthpart or a siphoning mouthpart not work properly when a bed bug is feeding?

If you have been "bitten" by a bed bug, what does the row of bites mean?

A row of bites is where a bed bug has been feeding. The bites are in rows either because they were disturbed when feeding and then fed again OR several bed bugs were feeding along the folds in the sheets.

What are some other places that bed bugs can find blood to feed on?

While bed bugs prefer humans, they will feed on other animals such as rats or mice, chickens, pets, bats, etc.

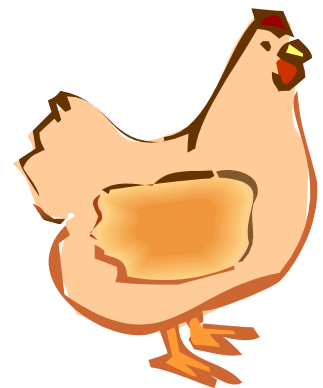

Let's Apply:

When bed bugs "bite" do they transfer a disease? What would you say to someone that thinks they may have gotten the flu from a bed bug bite?

Possible answer:

When bed bugs feed, they are not known to transfer any diseases. Being bitten from a bed bug cannot give you the flu. But you can get a secondary bacterial infection from the "bite" itself.

Why does a bed bug have to feed? What does that say about how the bed bug is growing?

Possible answers:

Immature bed bugs feed so that they can molt to the next instar (stage) of their life cycle.

Adult females feed so that they can make more eggs.

Male bed bugs feed so that they can make more sperm.

All bed bugs feed to obtain nutrition.

A bed bug feeds so that it can grow and reproduce. As bed bugs go through their different life stages, the bed bug population increases which means that you have an infestation!

If bed bugs feed from dusk to dawn then are we likely to see them during the day, like at school? Would they be feeding on us during the day?

If bed bugs are found at school then they probably came with someone from home. Most bed bugs would not be feeding during the day unless it is dark (like a movie theatre) and the person is sitting still or lying down. However if the bed bugs are really hungry (haven't been fed in several days—weeks, they will actively seek out a host during the day.



Notes:

Type of mouthpart

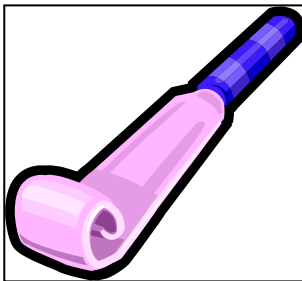
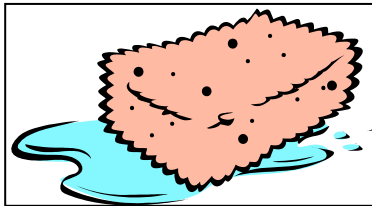

Insect

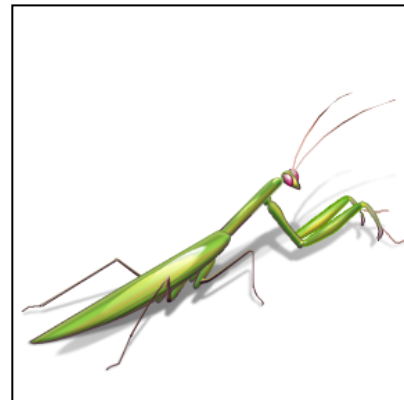
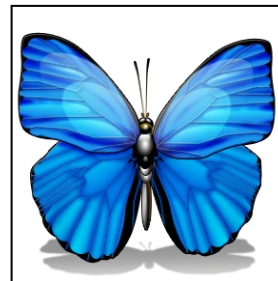
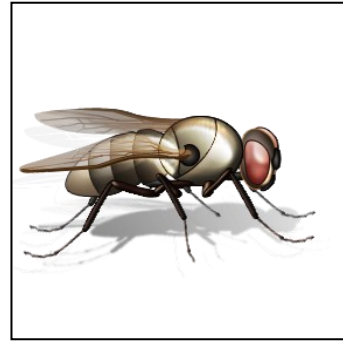

Type of mouthpart

Insect

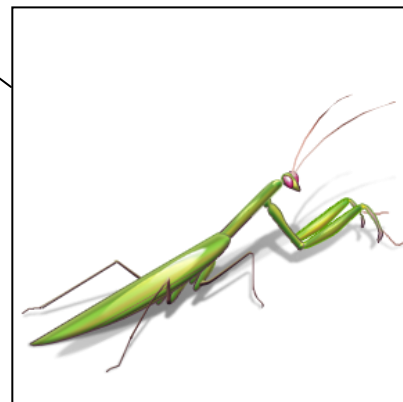
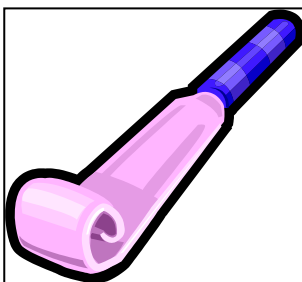
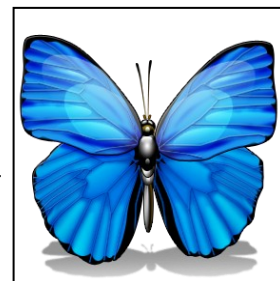
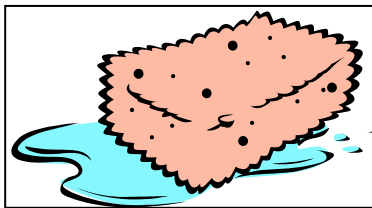
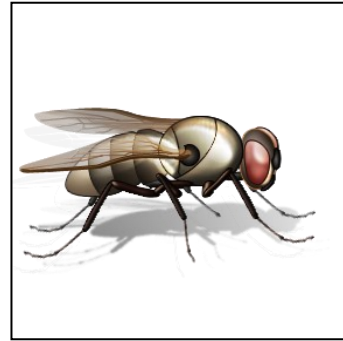

Bed Bugs Bite

Draw the rest of the person then draw bed bug bites where they might be most often found. Can you get sick or get a disease from a bed bug like the flu?

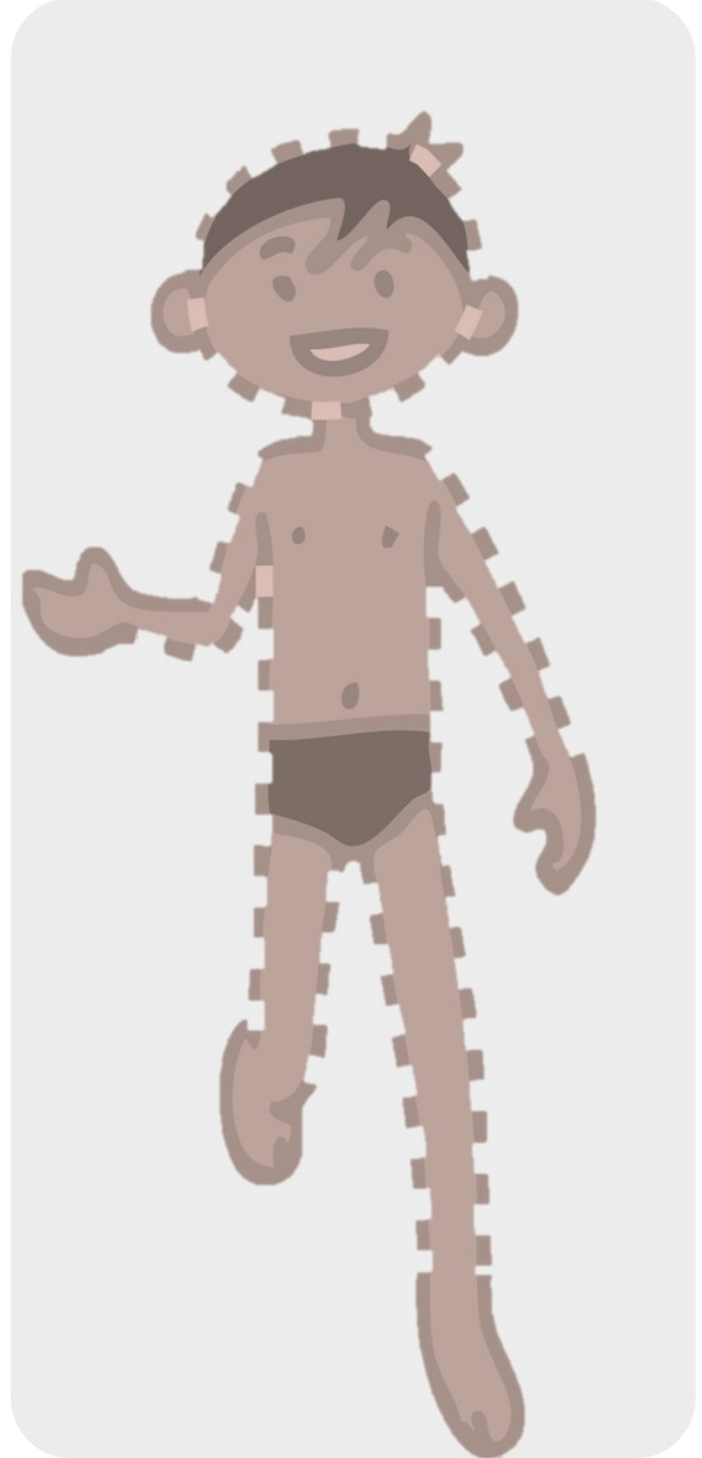
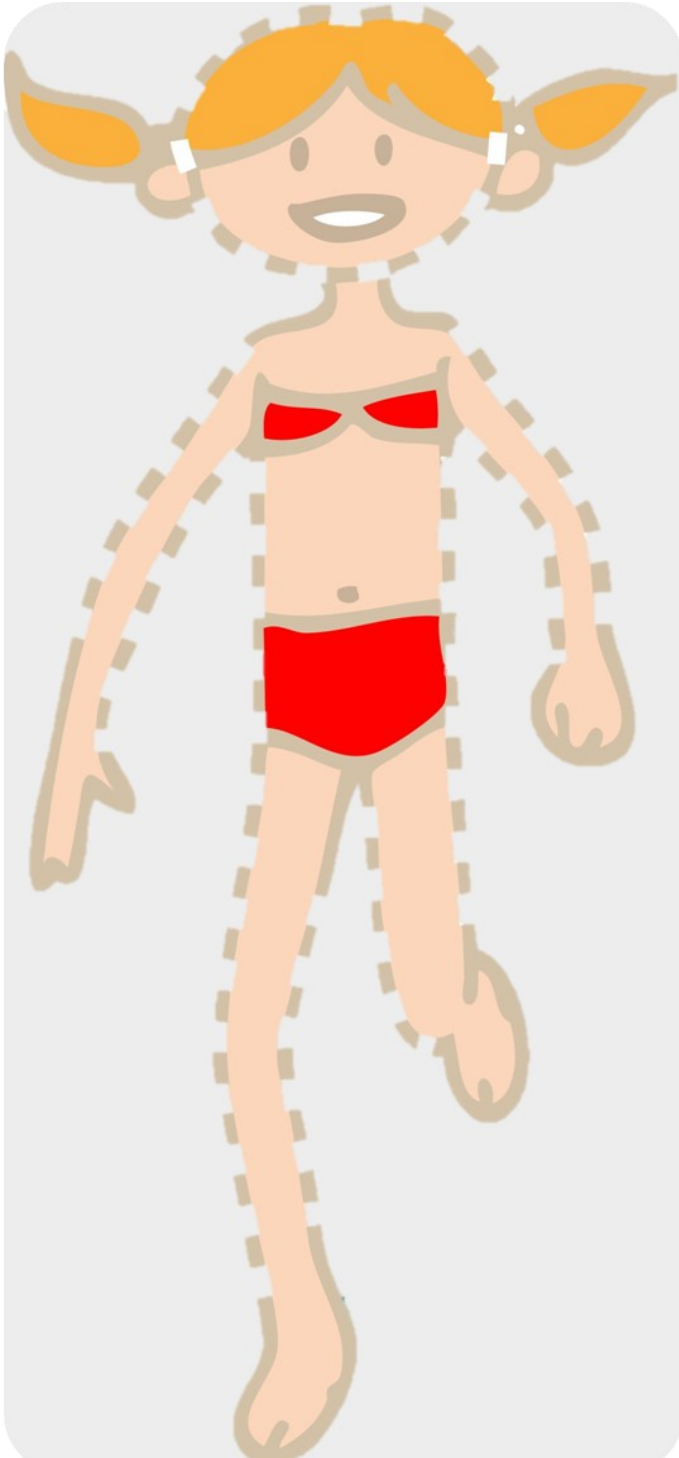



Can the following children get bed bug bites?

Put in red dots where you would find bed bugs bites and talk in groups about how each child could have been bitten.

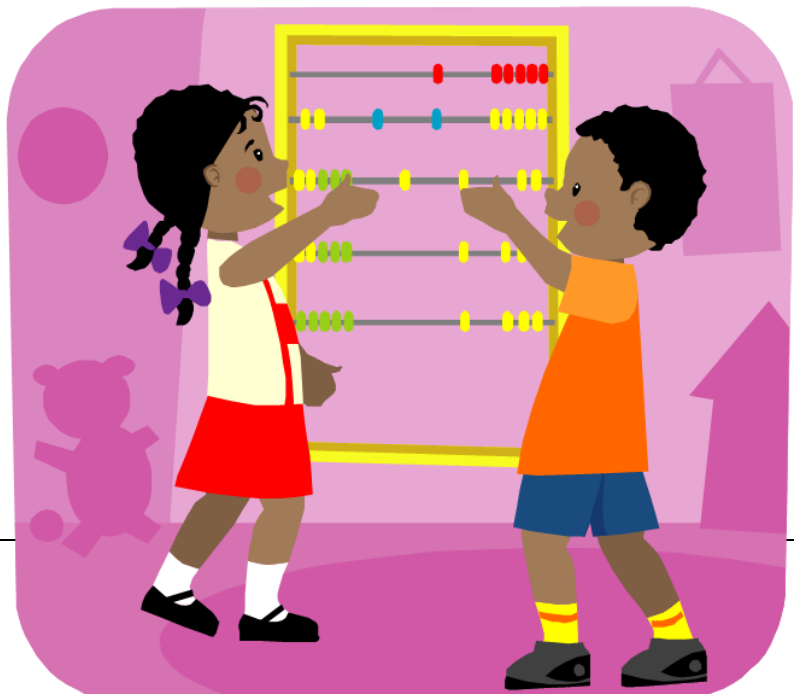
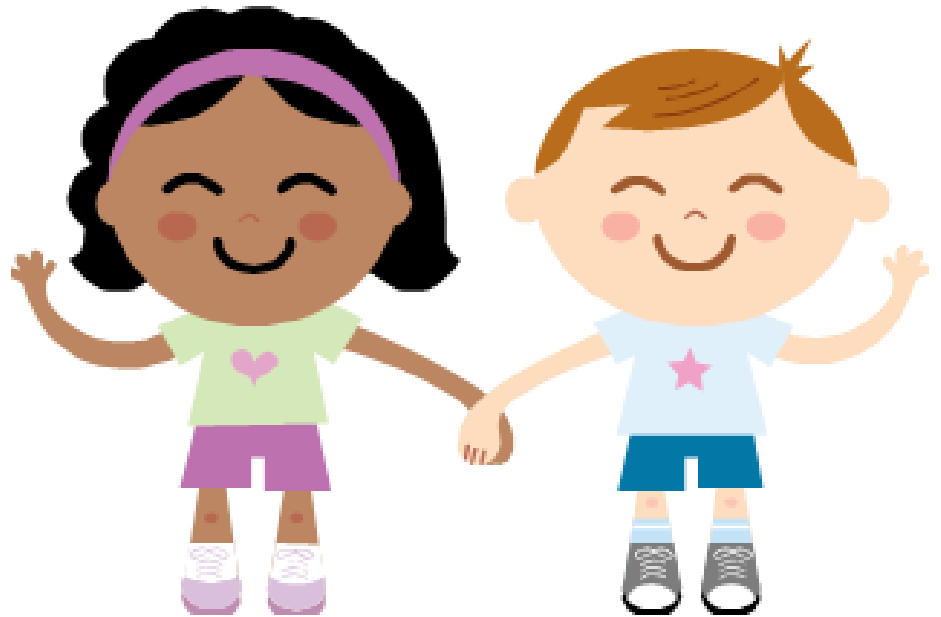

WHAT TO FEED BERNIE?

DIRECTIONS: Bernie the bed bug is hungry!! We know Bernie can feed on humans, but what other things could Bernie feed on? Put a circle around the items on the banquet table that Bernie could feed on. If there is anything else you know of on which Bernie can feed, write it beside the table as well!



WHAT TO FEED BERNIE?

DIRECTIONS: Bernie the bed bug is hungry!! We know Bernie can feed on humans, but what other things could Bernie feed on? Put a circle around the items on the banquet table that Bernie could feed on. If there is anything else you know of on which Bernie can feed, write it beside the table as well!

Additional Answers:
Rats, mice, hamsters, people,
squirrels, bats



Name _____

© www.TheTeachersCorner.net

Bed Bug Feeding Facts

DIRECTIONS: Write the letter of the correct match next to each problem.

- | | | |
|----------|--|--------------------|
| 1. _____ | Bed bugs can feed as low as this temperature | a. dawn |
| 2. _____ | Ideal temperature for bed bug feeding | b. 8 milligrams |
| 3. _____ | When feeding usually ends | c. 80° F |
| 4. _____ | How long a bed bug can survive without food | d. 44° F |
| 5. _____ | How much blood a bed bug consumes at a time | e. 10 minutes |
| 6. _____ | When feeding usually starts | f. midnight |
| 7. _____ | Bed bugs usually feed for this long | g. 275 to 400 days |

Created with the [Match Up Maker](#) © The Teacher's Corner

Name _____
© www.TheTeachersCorner.net

Bed Bug Feeding Facts

DIRECTIONS: Write the letter of the correct match next to each problem.

- | | | | |
|----|---|--|--------------------|
| 1. | d | Bed bugs can feed as low as this temperature | a. dawn |
| 2. | c | Ideal temperature for bed bug feeding | b. 8 milligrams |
| 3. | a | When feeding usually ends | c. 80° F |
| 4. | g | How long a bed bug can survive without food | d. 44° F |
| 5. | b | How much blood a bed bug consumes at a time | e. 10 minutes |
| 6. | f | When feeding usually starts | f. midnight |
| 7. | e | Bed bugs usually feed for this long | g. 275 to 400 days |

Created with the [Match Up Maker](#) © The Teacher's Corner

Bed Bug Feeding Crossword

Please complete the crossword puzzle below.

Created with the [Crossword Maker](#) © The Teacher's Corner

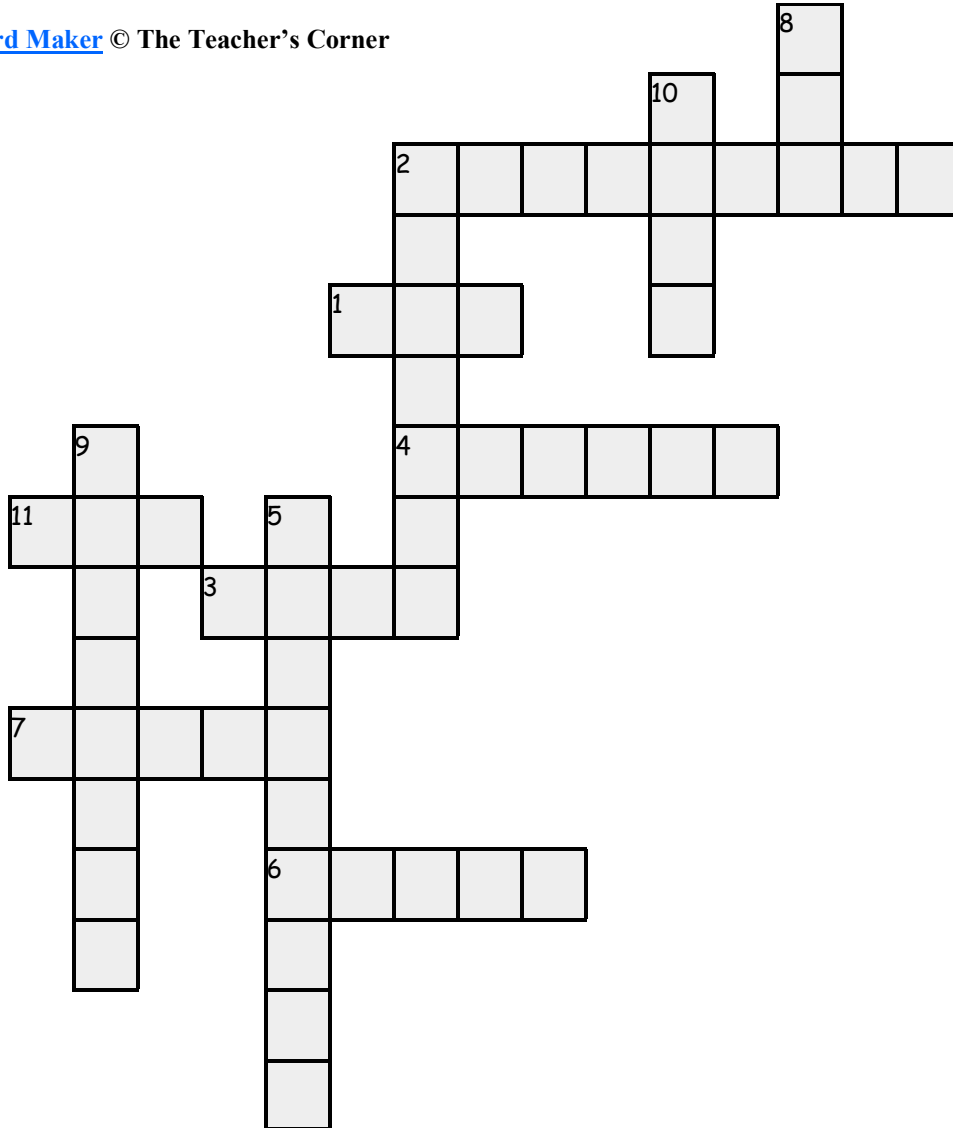

WORDBANK: Ten, midnight, one year, eight, dawn, eighty, forty four, once a week, fifty, six, one, four

ACROSS:

- 1. Bed bugs usually feed for _____ minutes
- 3. Adult bed bugs can run _____ feet per minute
- 4. Ideal temperature for bed bug feeding is _____ ° F
- 2. This is how often bed bugs feed on average
- 6. What percent of blood is excreted 5 hrs after it is consumed?
- 7. Bed bugs consume _____ milligrams of blood at a time
- 11. How many legs do bed bugs have?

DOWN:

- 2. How long can a bed bug survive without a blood meal?
- 5. Bed bugs can feed at temperatures as low as this: _____ ° F
- 8. Immature bed bugs can run _____ feet per minute
- 9. This is when feeding usually starts
- 10. This is when feeding usually ends

Name: _____

Provided By: www.TheTeachersCorner.net

Bed Bug Feeding Crossword

Please complete the crossword puzzle below.

Created with the [Crossword Maker](#) © The Teacher's Corner

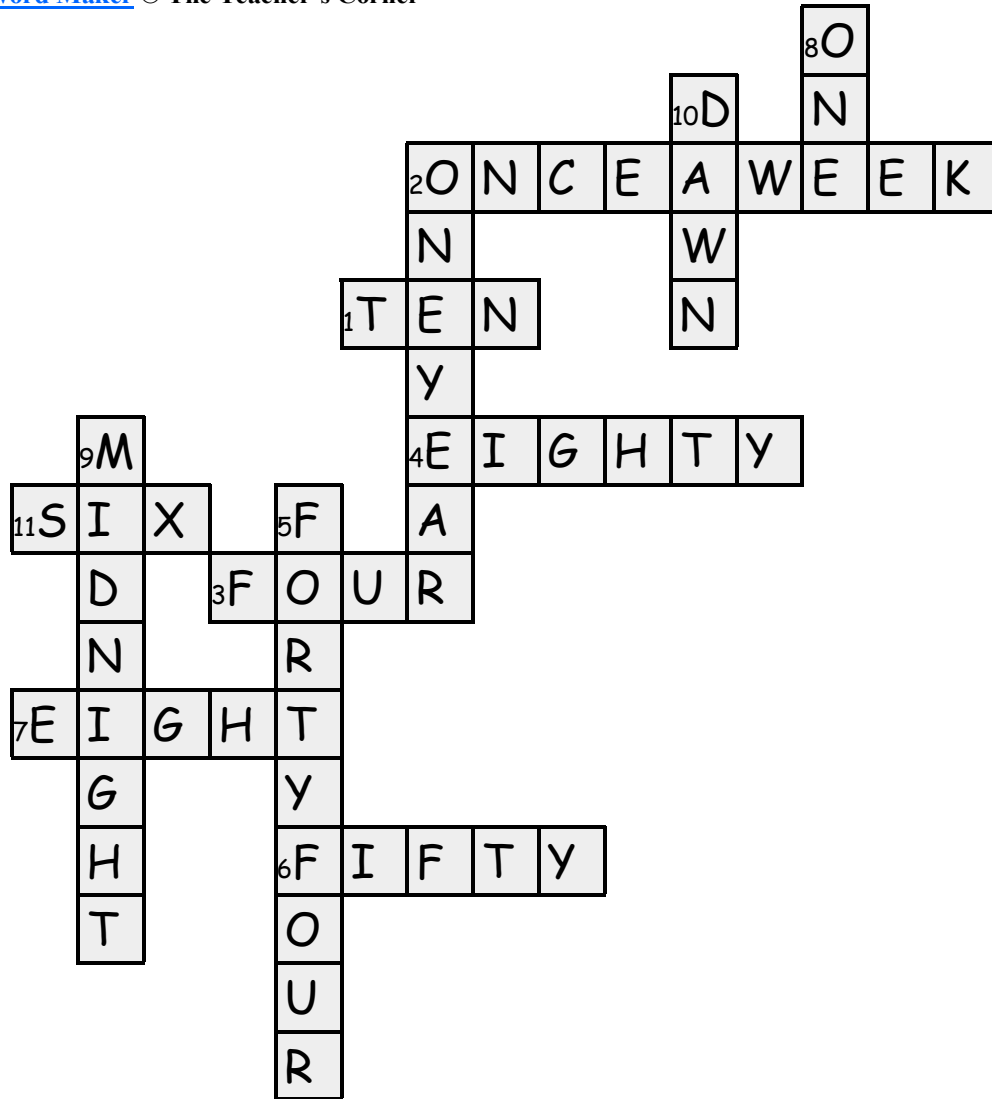

Answers: Ten, midnight, one year, eight, dawn, eighty, forty four, once a week, fifty, six, one, four

ACROSS:

1. Bed bugs usually feed for _____ minutes
3. Adult bed bugs can run _____ feet per minute
4. The Ideal temperature for bed bug feeding: _____ ° F
2. How often do bed bugs feed on average?
6. What percent of blood is excreted 5 hrs after it is consumed?
7. Bed bugs consume _____ milligrams of blood at a time
11. How many legs do bed bugs have?

DOWN:

2. How long can a bed bug can survive without a blood meal?
5. Bed bugs can feed at temperatures as low as this: _____ ° F
8. Immature bed bugs can run feet per minute
9. This is when feeding usually starts
10. This is when feeding usually ends

Name: _____

Provided By: www.TheTeachersCorner.net

Bed Bug International

KEY CONCEPT:

Children problem-solve to focus on deciding what to do in a situation concerning bed bug infestation. Children also see the value in cultural diversity.

OBJECTIVES:

Students will be able to:

- Determine how bed bugs move from one person to another.
- Recognize that bed bugs can be found anywhere in the world and across different cultures and generations.



ACTIVITY INTRODUCTION:

Bed bugs can be transported in a number of different methods. It is important for students to recognize how bed bugs are transported and that they are not specific to a culture, location, or type of person.

Let's Do:

For 3rd graders - Distribute at least one bed bug card per student. In groups, students should cut out the country cards. Then, students will draw a card with a country on it where bed bugs are found, then attach a bed bug onto a classroom map. Alternatively, students can clip modes of transportation out of magazines (boats, airplanes, cruise ships, cars, trains, buses, wagons, donkeys, skateboard, feet, horses, feet, roller skates, etc.). Teachers can list countries and have the student explain how bed bugs could or could not be transported using their mode of transportation.

For 4th & 5th graders -This activity is small group oriented. Divide students in to groups of 3 or 4 and have them draw random cards of countries as a small group. Have them create a story of the hitchhiking bed bugs by describing how bed bugs traveled from these countries to get to their book bags at school in the U.S.--they can incorporate researching the country for modes of transportation, etc.---skills incorporate more critical thinking, creativity and communication skills.

LEARNING CONCEPT:

- Critical Understanding

GRADE LEVEL: 3-5

SUBJECT: Health, Science, Geography

SETTING: Indoors; classroom with desks or tables

TIME NEEDED: 30-45 minutes

ENTOMOLOGY SKILL:

Recognizing where and how bed bugs are transported

LIFE SKILL: Understanding cultural diversity and that anyone has the potential to get bed bugs

SUNSHINE STATE

STANDARDS:

HE.3.C.2.1, HE.3.C.2.2
HE.4.C.2.1, HE.4.C.2.2, HE.4.B3.1
HE.5.C.2.7, HE.5.C.2.1, HE.5.C.2.2

MATERIALS NEEDED:

- Copies of world cards and at least one bed bug for each child.
- Classroom size world map.
- Scotch tape, scissors

VOCABULARY: infestation, introduction

TEACHER REVIEW:

Section 1.10 - Section 1.14

Let's Reflect:

As a group, discuss why the bed bugs are all over the world. Ask the students the following questions:

If bed bugs are found all over the world, do you think anyone can get bed bugs? Bed bugs can infest anyone no matter where they live, their age, gender, or ethnicity.

If they are found all over the world, do you think that they are just found near beds?

Where else might they be found?

Bed bugs prefer tight, dark spaces in which to live. They can be found in movie theatres, bedrooms, couches, airplanes, etc.

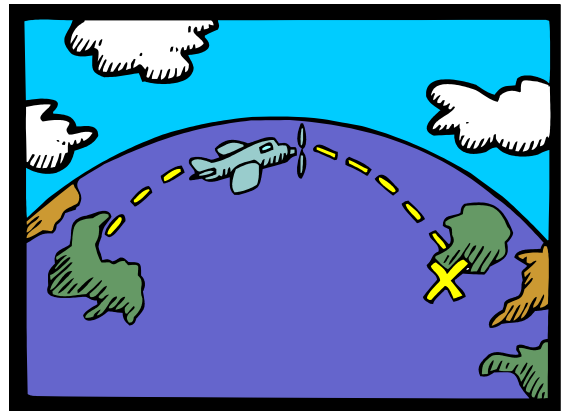

EXTENSION:

Because bed bugs do not fly, discuss how bed bugs can be moved from one person to another through this activity.

Use the internet to find different places where bed bugs have been found such as movie theatres, airplanes, schools, etc. After discussing how bed bugs in these places would affect their lives, have each student choose a mode of transportation or location to represent with a picture. Standing in a circle, have students toss a ball of string (representing a bed bug) from one person to the next. They should create a story of how the “bed bug” is moving and what it is doing at that location. Encourage creativity in the story.

Let's Apply:

How do bed bugs move from one person to another if they can be found anywhere? (Consider using extension activity to help them understand this point). Bed bugs may hitchhike on clothes, bags, book bags or luggage, etc.

Why is it important to know that bed bugs can be anywhere and anyone can have them? It is important for students to understand that bed bugs are not bound by societal, cultural, or economic lines and that they should treat everyone with respect.

How could a bed bug move from someone's house to school and back again? Bed bugs could move on book bags or clothes. Plastic bins with tight fitting lids can help to eliminate transfer of bed bugs.

How would they protect themselves from bed bugs now that they know they can be anywhere? Is there anything in particular they would do?

How would they feel if they had bed bugs at home or knew someone that did? Could they get them? How would they treat that person or how would they want to be treated?



Notes:

VOCABULARY:

Introduction: The transportation of bed bugs (e.g. in clothing, luggage, furniture) into an uninfested area.

Infestation: When all stages of bed bugs (eggs, various nymph stages and adults) are found in a given environment.



England

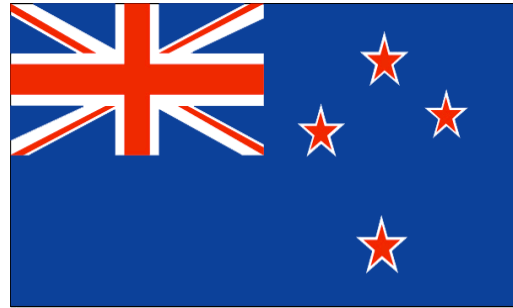

New Zealand

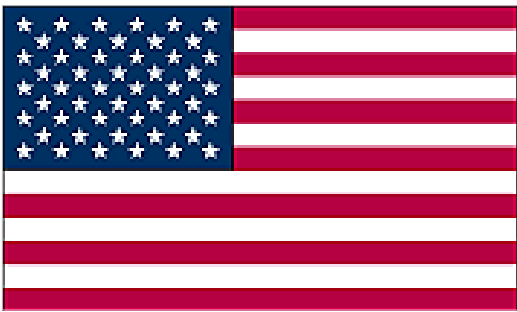

United States







Canada



South Africa

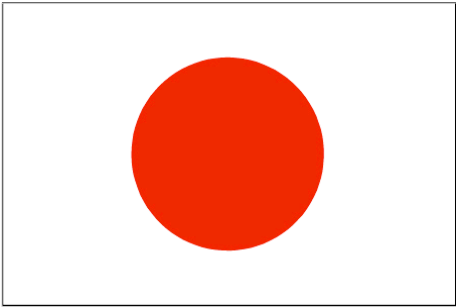
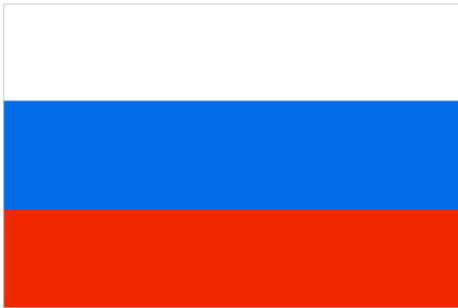

Italy

 <p>India</p>	 <p>Japan</p>
 <p>Russia</p>	 <p>Mexico</p>
 <p>China</p>	 <p>Egypt</p>



Germany



Saudi Arabia

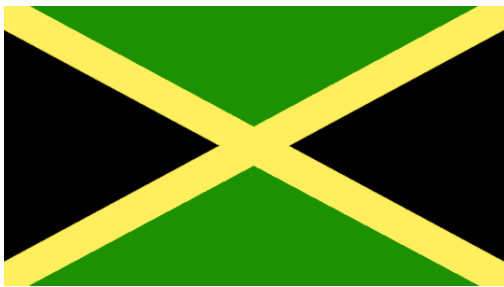

Jamaica



Cuba



Brazil



Trinidad and Tobago

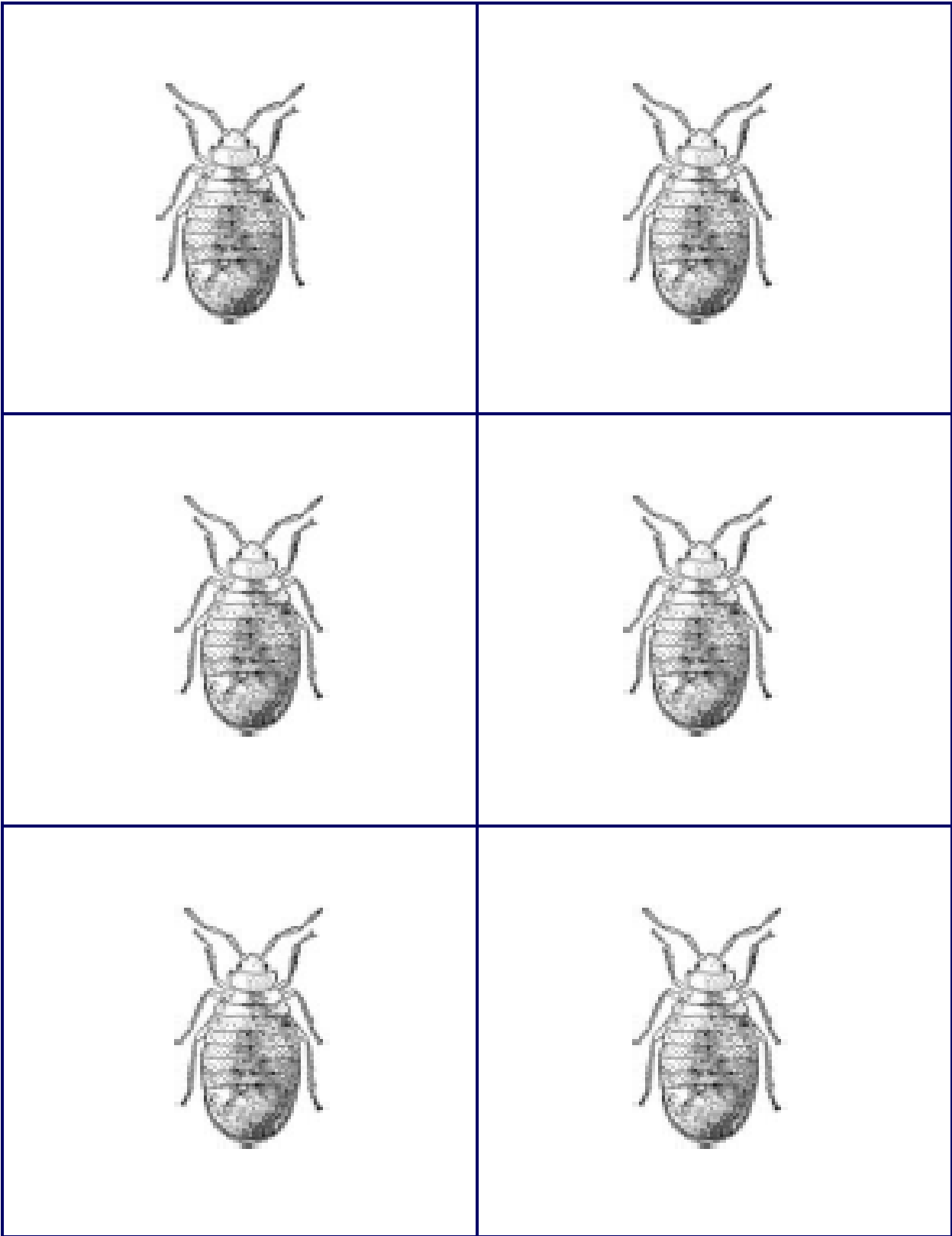

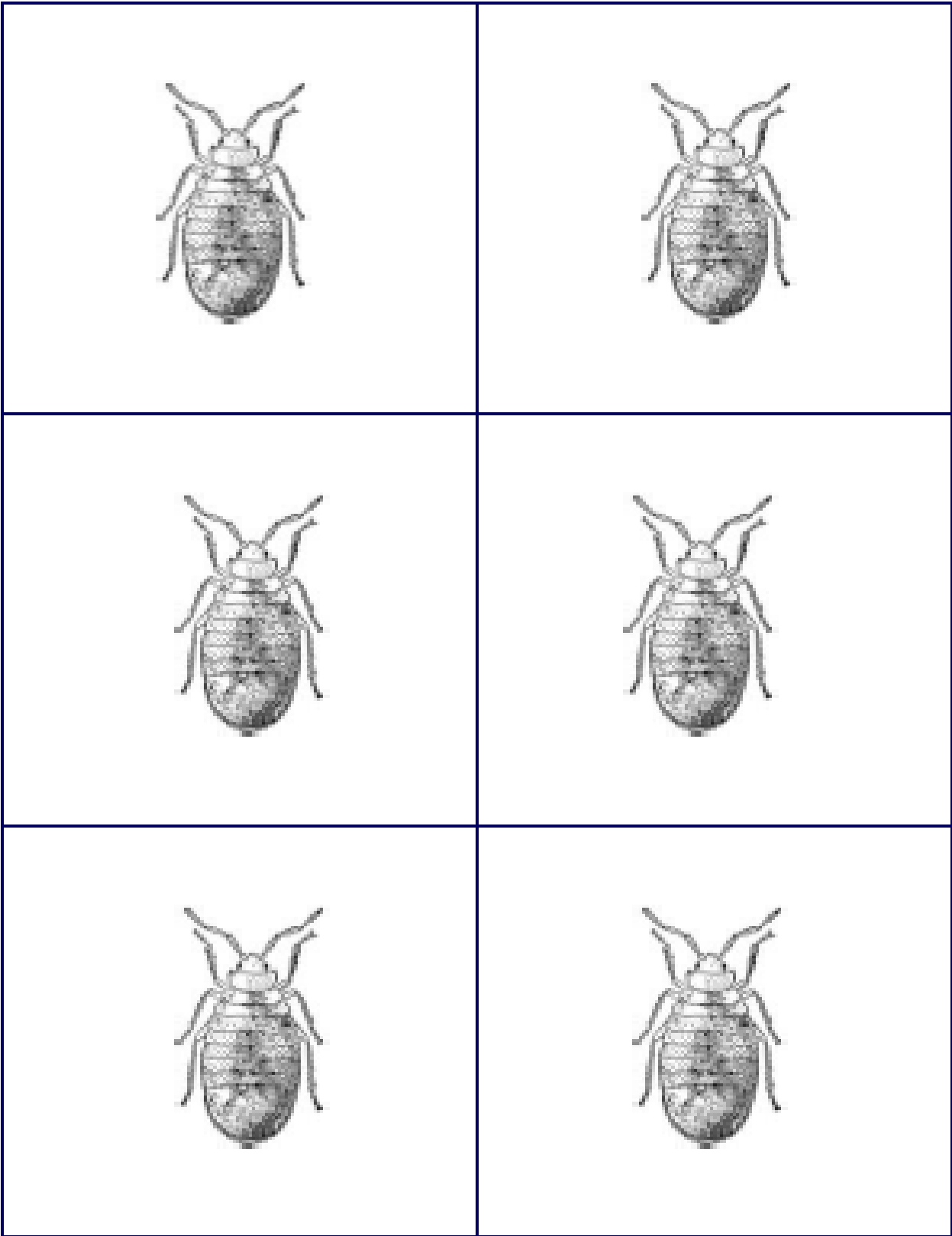

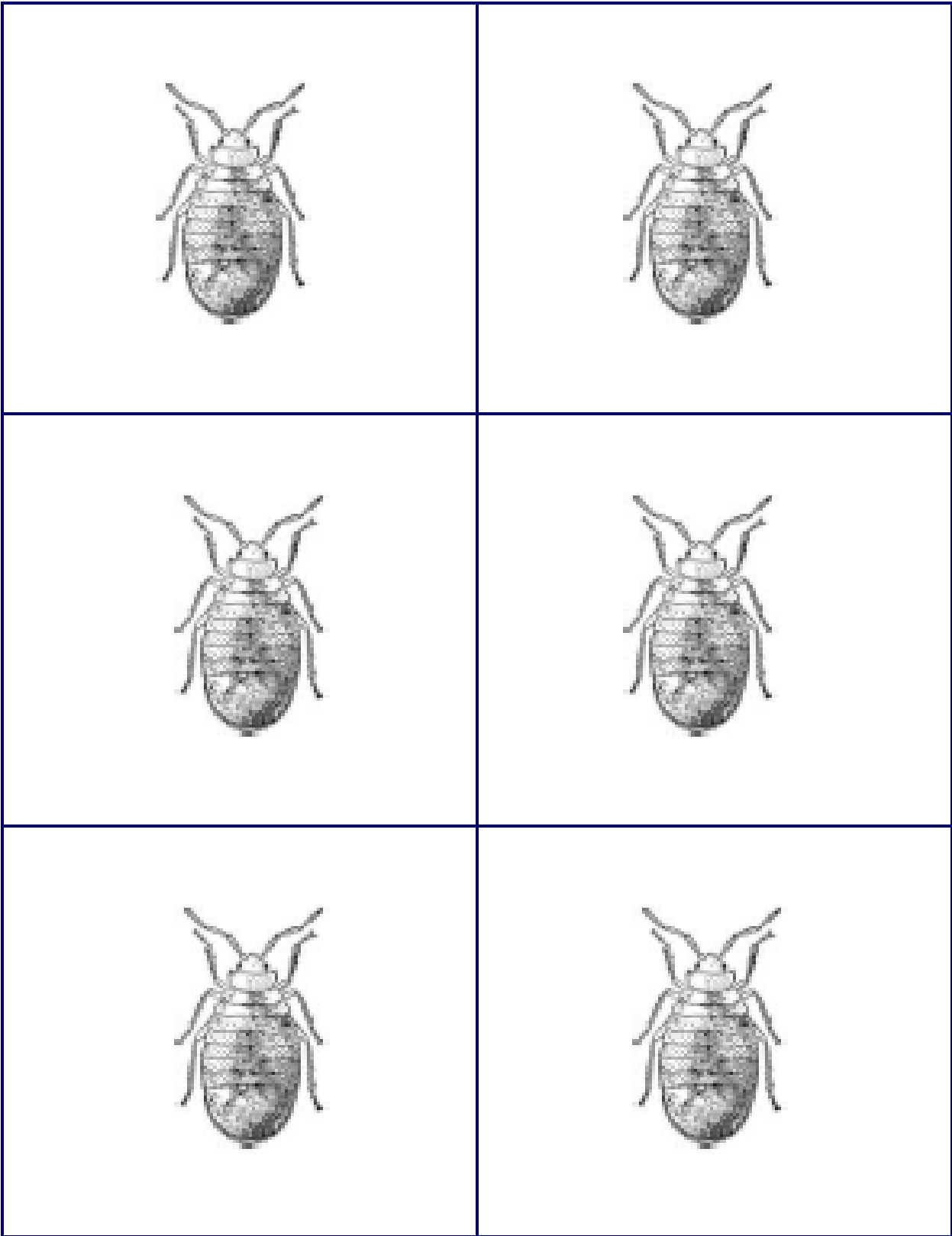

Bed Bug Biology

KEY CONCEPT:

- Children begin to understand that there is a relationship between the environment and themselves.

OBJECTIVES:

Students will be able to:

- Recognize that insects are classified based on their similarities and differences .
- Identify the characteristics of bed bugs as compared to similar insects.
- Complete and understand the life cycle of a bed bug.

ACTIVITY INTRODUCTION:

Explain to students that there are many different common names given to insects. Many times one insect can have more than one common name, e.g., bed bugs are known as chinchies, chintzes, mahogany flats, red coats, wall louse, house bugs and crimson ramblers. Sometimes different insects can have the same common name! How confusing! To avoid this confusion, a scientific name is given to an insect and it is under the binomial nomenclature system developed by a famous scientist, Carolus Linnaeus. Each insect has a unique scientific name to tell it apart from another insect. Do you know the scientific name for bed bugs? In addition to knowing how to name a bed bug, you should also know about its biology and be able to describe it. That also includes understanding its life cycle. It helps to know exactly how your pest is progressing so that you can help to manage it should it get out of control.

LEARNING CONCEPT:

- Environmental Understanding

GRADE LEVEL: 3-5

SUBJECT: Health, Science

SETTING: Indoors; classroom with desks or tables

TIME NEEDED: 30-45 minutes

ENTOMOLOGY SKILL: Classifying, comparing, identifying

LIFE SKILL: Understanding how living things are similar and different when compared to each other

SUNSHINE STATE STANDARDS:

HE.3.P.1.2

HE.4.B.1.1, HE.4.C.1.3, HE.4.P.1.3

HE.5.P.1.3

MATERIALS NEEDED:

Make several copies of the crossword puzzle to hand out to each student.

Make copies of "Describe the culprit" and give to pairs of students.

Make copies of life cycle game to give to pairs of students

TEACHER REVIEW:

Section: 1.1

Section: 1.3

Section : 1.4

Section: 1.9

Let's Do:

1. Have students complete the crossword puzzle "Classify a Bed Bug!"
2. Discuss the importance of having a scientific name.
3. Have students complete the "*Describe the Culprit*" game and discuss with them the characteristics of a bed bug as compared to similar insects.
4. Evaluate the student activity sheets to make sure they are correct.
5. Look at the life cycle of a bed bug and the mouthparts of a bed bug. Have students assemble the life cycle puzzle in pairs.
6. Have students complete the Bed Bug Symmetry diagram and label the finished bed bug.

Let's Reflect:

Why is it important to classify organisms?

What did you find were some important similarities between bed bugs and the other insects you learned about today?

How can you find the scientific name for other organisms?

Use the internet, look in textbooks



Let's Apply:

What are some ways in which scientific names are better than common names?

They help us to know the specific organism to which we are referring. It cuts down on confusion. Anyone from anywhere in the world can know the specific insect when you use the scientific name compared to the common name, etc.

How long does it take for the bed bug to go through its life cycle? What does this mean for how quickly we can get an infestation?

4-9 weeks, this means that within 2 months, there can be a major infestation.

CLASSIFY a BED BUG!

DIRECTIONS: Unscramble each of the clue words. Copy the letters in the numbered cells to other cells with the same number.

MAILANAI	<table border="1" style="border-collapse: collapse; text-align: center;"> <tr><td style="width: 20px; height: 20px;"></td><td style="width: 20px; height: 20px;"></td><td style="width: 20px; height: 20px;"></td><td style="width: 20px; height: 20px;"></td><td style="width: 20px; height: 20px;"></td><td style="width: 20px; height: 20px;"></td><td style="width: 20px; height: 20px;"></td><td style="width: 20px; height: 20px;"></td></tr> <tr> <td></td><td></td><td></td><td></td><td></td><td>5</td><td>2</td><td>9</td> </tr> </table>														5	2	9	Kingdom to which bed bugs belong				
					5	2	9															
TOAPROHDAR	<table border="1" style="border-collapse: collapse; text-align: center;"> <tr><td style="width: 20px; height: 20px;"></td><td style="width: 20px; height: 20px;"></td><td style="width: 20px; height: 20px;"></td><td style="width: 20px; height: 20px;"></td><td style="width: 20px; height: 20px;"></td><td style="width: 20px; height: 20px;"></td><td style="width: 20px; height: 20px;"></td><td style="width: 20px; height: 20px;"></td><td style="width: 20px; height: 20px;"></td><td style="width: 20px; height: 20px;"></td></tr> <tr> <td></td><td>10</td><td>8</td><td></td><td></td><td></td><td></td><td></td><td></td><td></td> </tr> </table>												10	8								Phylum to which bed bugs belong
	10	8																				
SICTENA	<table border="1" style="border-collapse: collapse; text-align: center;"> <tr><td style="width: 20px; height: 20px;"></td><td style="width: 20px; height: 20px;"></td><td style="width: 20px; height: 20px;"></td><td style="width: 20px; height: 20px;"></td><td style="width: 20px; height: 20px;"></td><td style="width: 20px; height: 20px;"></td><td style="width: 20px; height: 20px;"></td></tr> <tr> <td></td><td></td><td>12</td><td>4</td><td>7</td><td></td><td></td> </tr> </table>										12	4	7			Class to which bed bugs belong						
		12	4	7																		
REMPIATEH	<table border="1" style="border-collapse: collapse; text-align: center;"> <tr><td style="width: 20px; height: 20px;"></td><td style="width: 20px; height: 20px;"></td><td style="width: 20px; height: 20px;"></td><td style="width: 20px; height: 20px;"></td><td style="width: 20px; height: 20px;"></td><td style="width: 20px; height: 20px;"></td><td style="width: 20px; height: 20px;"></td><td style="width: 20px; height: 20px;"></td><td style="width: 20px; height: 20px;"></td></tr> <tr> <td></td><td>6</td><td>3</td><td></td><td></td><td></td><td></td><td></td><td></td> </tr> </table>											6	3							Order to which bed bugs belong		
	6	3																				
CIMCIIADE	<table border="1" style="border-collapse: collapse; text-align: center;"> <tr><td style="width: 20px; height: 20px;"></td><td style="width: 20px; height: 20px;"></td><td style="width: 20px; height: 20px;"></td><td style="width: 20px; height: 20px;"></td><td style="width: 20px; height: 20px;"></td><td style="width: 20px; height: 20px;"></td><td style="width: 20px; height: 20px;"></td><td style="width: 20px; height: 20px;"></td><td style="width: 20px; height: 20px;"></td></tr> <tr> <td></td><td>11</td><td></td><td></td><td>1</td><td></td><td></td><td></td><td></td> </tr> </table>											11			1					Family to which bed bugs belong		
	11			1																		

What is the scientific name for the common bed bug?

				X					U					U		
1	2	3	4		5	6	7	8		5	9	10	11		12	

CLASSIFY a BED BUG!

DIRECTIONS: Unscramble each of the clue words. Copy the letters in the numbered cells to other cells with the same number.

MAILANAI	<table border="1" style="margin: auto;"> <tr> <td style="padding: 5px;">A</td><td style="padding: 5px;">N</td><td style="padding: 5px;">I</td><td style="padding: 5px;">M</td><td style="padding: 5px;">A</td><td style="padding: 5px;">L</td><td style="padding: 5px;">I</td><td style="padding: 5px;">A</td> </tr> <tr> <td></td><td></td><td></td><td></td><td></td><td style="text-align: center;">5</td><td style="text-align: center;">2</td><td style="text-align: center;">9</td> </tr> </table>	A	N	I	M	A	L	I	A						5	2	9	Kingdom to which bed bugs belong				
A	N	I	M	A	L	I	A															
					5	2	9															
TOAPROHDAR	<table border="1" style="margin: auto;"> <tr> <td style="padding: 5px;">A</td><td style="padding: 5px;">R</td><td style="padding: 5px;">T</td><td style="padding: 5px;">H</td><td style="padding: 5px;">R</td><td style="padding: 5px;">O</td><td style="padding: 5px;">P</td><td style="padding: 5px;">O</td><td style="padding: 5px;">D</td><td style="padding: 5px;">A</td> </tr> <tr> <td></td><td></td><td style="text-align: center;">10</td><td style="text-align: center;">8</td><td></td><td></td><td></td><td></td><td></td><td></td> </tr> </table>	A	R	T	H	R	O	P	O	D	A			10	8							Phylum to which bed bugs belong
A	R	T	H	R	O	P	O	D	A													
		10	8																			
SICTENA	<table border="1" style="margin: auto;"> <tr> <td style="padding: 5px;">I</td><td style="padding: 5px;">N</td><td style="padding: 5px;">S</td><td style="padding: 5px;">E</td><td style="padding: 5px;">C</td><td style="padding: 5px;">T</td><td style="padding: 5px;">A</td> </tr> <tr> <td></td><td></td><td style="text-align: center;">12</td><td style="text-align: center;">4</td><td style="text-align: center;">7</td><td></td><td></td> </tr> </table>	I	N	S	E	C	T	A			12	4	7			Class to which bed bugs belong						
I	N	S	E	C	T	A																
		12	4	7																		
REMPIATEH	<table border="1" style="margin: auto;"> <tr> <td style="padding: 5px;">H</td><td style="padding: 5px;">E</td><td style="padding: 5px;">M</td><td style="padding: 5px;">I</td><td style="padding: 5px;">P</td><td style="padding: 5px;">T</td><td style="padding: 5px;">E</td><td style="padding: 5px;">R</td><td style="padding: 5px;">A</td> </tr> <tr> <td></td><td style="text-align: center;">6</td><td style="text-align: center;">3</td><td></td><td></td><td></td><td></td><td></td><td></td> </tr> </table>	H	E	M	I	P	T	E	R	A		6	3							Order to which bed bugs belong		
H	E	M	I	P	T	E	R	A														
	6	3																				
CIMCIIADE	<table border="1" style="margin: auto;"> <tr> <td style="padding: 5px;">C</td><td style="padding: 5px;">I</td><td style="padding: 5px;">M</td><td style="padding: 5px;">I</td><td style="padding: 5px;">C</td><td style="padding: 5px;">I</td><td style="padding: 5px;">D</td><td style="padding: 5px;">A</td><td style="padding: 5px;">E</td> </tr> <tr> <td></td><td></td><td style="text-align: center;">11</td><td></td><td style="text-align: center;">1</td><td></td><td></td><td></td><td></td> </tr> </table>	C	I	M	I	C	I	D	A	E			11		1					Family to which bed bugs belong		
C	I	M	I	C	I	D	A	E														
		11		1																		

What is the scientific name for the common bed bug?

C	I	M	E	X	L	E	C	T	U	L	A	R	I	U	S
1	2	3	4		5	6	7	8		5	9	10	11		12

DESCRIBE THE CULPRIT

DIRECTIONS: Last night there was a break in at the Bugville Blood Bank! Three criminal critters were brought into custody because they are all suspicious. They were suspected because they all like to feed on blood! The suspected critters were: Stanley the Stable Fly, Bruce the Bed Bug and Mariella the Mosquito. **The only two clues that were found were: 1) there was a drop of blood near one of the blood vaults and 2) footprints were found on the side of the vault**

Your job as the lead bug detective on this case is to:

1. Write down what the suspects have in common using the Venn diagram provided (e.g., all have six legs).
2. Using the two clues, discuss with your partner to figure out who actually stole the blood.
3. Once you have figured out “who did it”, write a good description of your “bad bug” using the Bugville Police Department Criminal Record Sheet.

Sheet 1 of 3



Stanley the Stable Fly



Bruce the Bed Bug



Mariella the Mosquito

**Bugville Police Department
Criminal Record Sheet**

Name of criminal:		Bird's eye view: Sketch suspect	
Common name:			
Scientific name:			
Pairs of legs?			
Number of antennae:		Lateral (side) view: Sketch suspect	
Number of wings?			
Are wings functional?			
Was the culprit male or female?		Crime?	Last known whereabouts?
How can you REALLY tell?			
Size:	Color:		

**Bugville Police Department
Criminal Record Sheet**

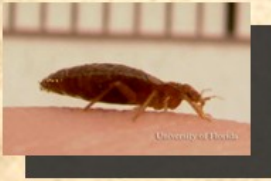
<p>Name of criminal: Bruce the bed bug Common name: Bed bug Scientific name: <i>Cimex lectularius</i></p>	<p>Bird's eye view: Sketch suspect</p> <p>Have students draw what a bed bug looks like looking down on it from above.</p> 	
<p>Pairs of legs? 6 (six) Number of antennae: 2 (two) Number of wings? None (wing pads) Are wings functional? NO</p>	<p>Lateral (side) view: Sketch suspect</p> <p>Have students draw bed bugs as it looks from the side</p> 	
<p>Was the culprit male or female? Female. Bruce was a fake name. How can you REALLY tell? Tip of abdomen is more rounded in females than males Size: ~ 4.5 - 5 mm Color: brownish, brown</p>	<p>Crime? Stealing blood from the Bugsville Blood bank.</p>	<p>Last known whereabouts? (students can list where they might find bed bugs) Eg. Bed, book bags, shoes, etc.</p>

Directions: Use the Venn Diagram to list the characteristics where appropriate

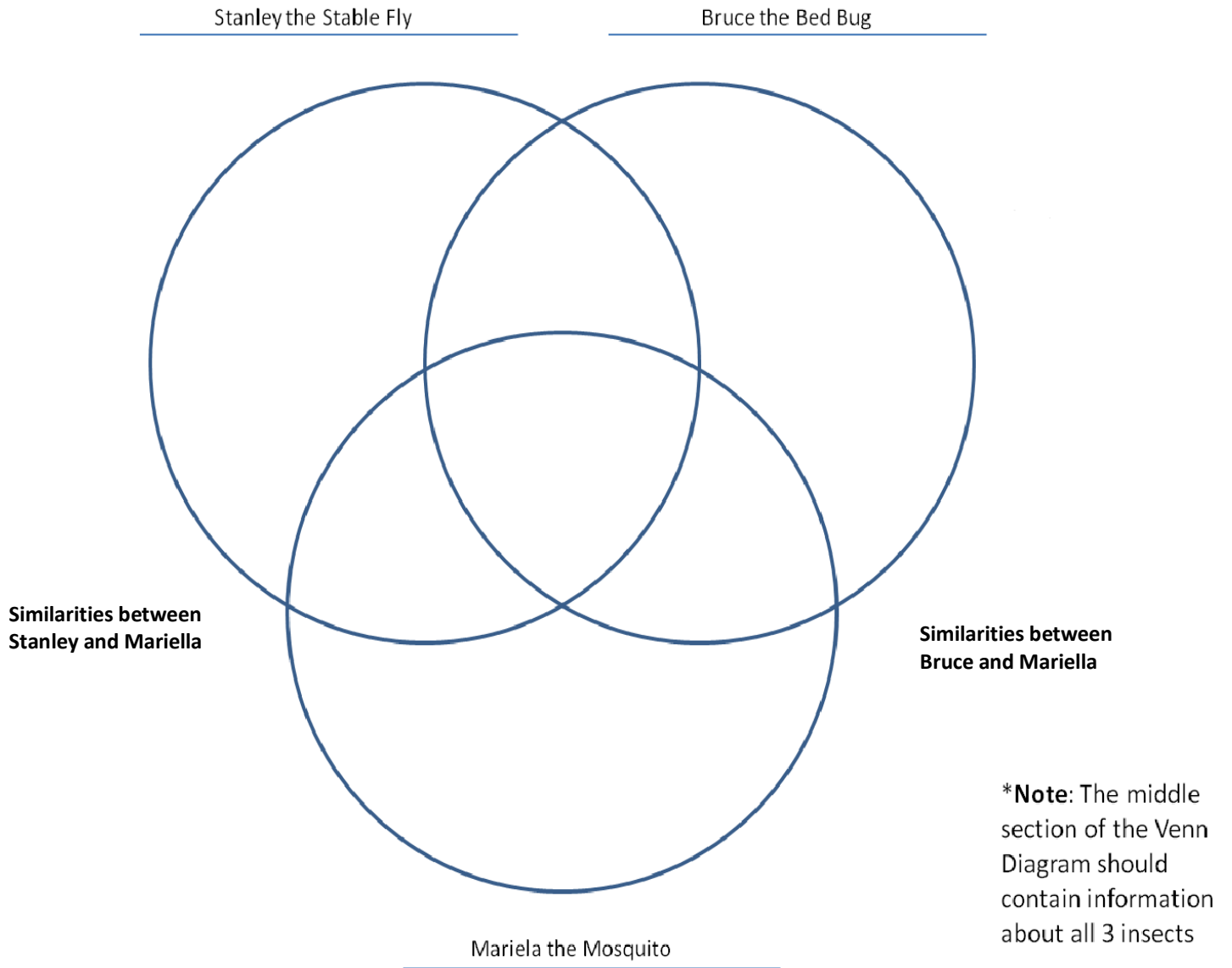

Directions: Use the Venn Diagram to list the characteristics where appropriate

Answer Key

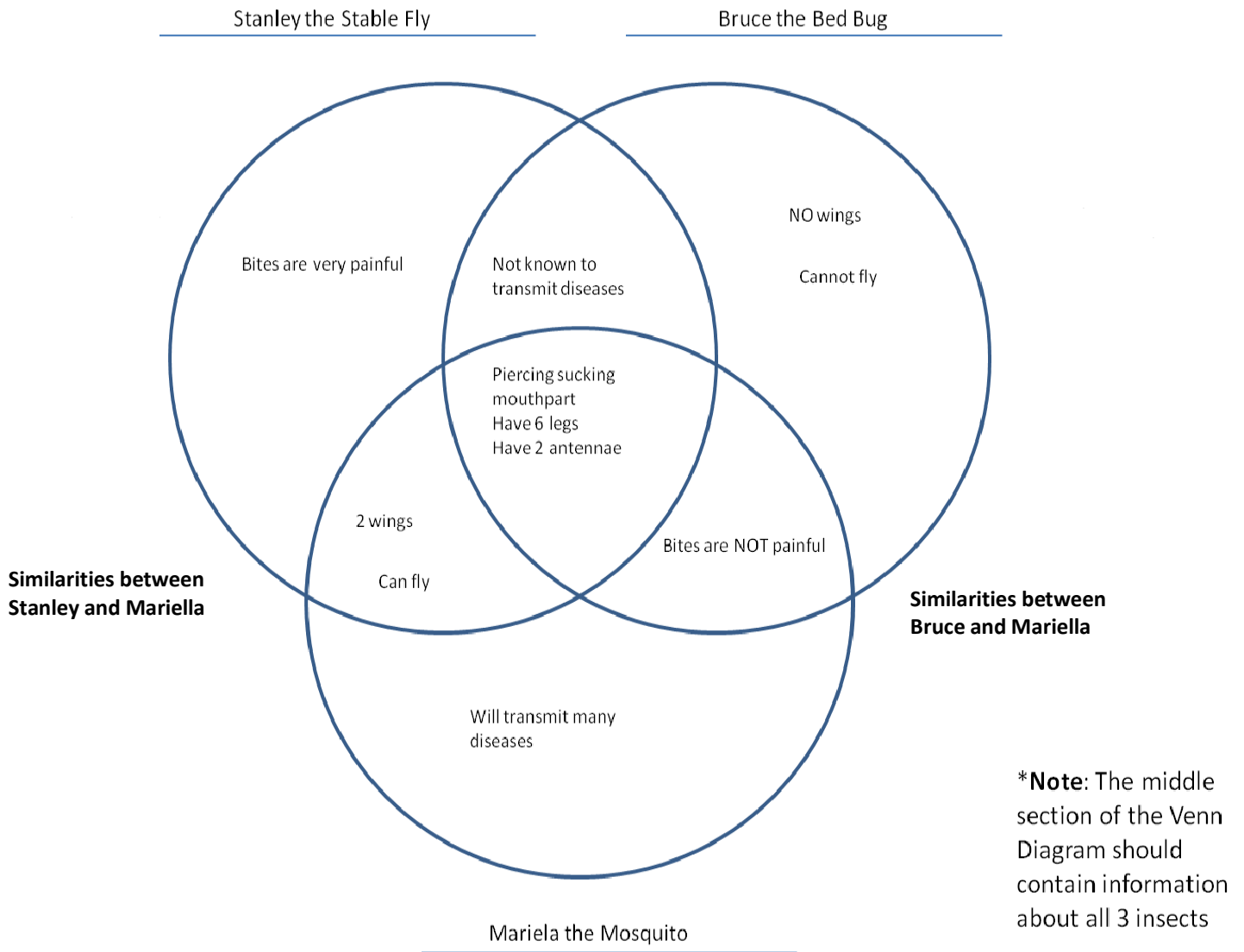

Directions of Life Cycle game:

TEACHER'S DIRECTIONS: Copy all tables as many times as needed to have enough to give to pairs of students in your class. Use the dotted lines to guide you in cutting out small squares that contains all the pictures, arrows and words. Give each student pair a copy of all the table squares (in a little zipper bag) so that they can work together to put the bed bug life cycle together. They will start the life cycle with the eggs square then use an arrow square to connect to the 1st instar nymph square and so on until they complete the cyclical pathway. The squares with the sentences should be correctly placed beside each life stage. The final product should look like a complete life cycle as shown below:

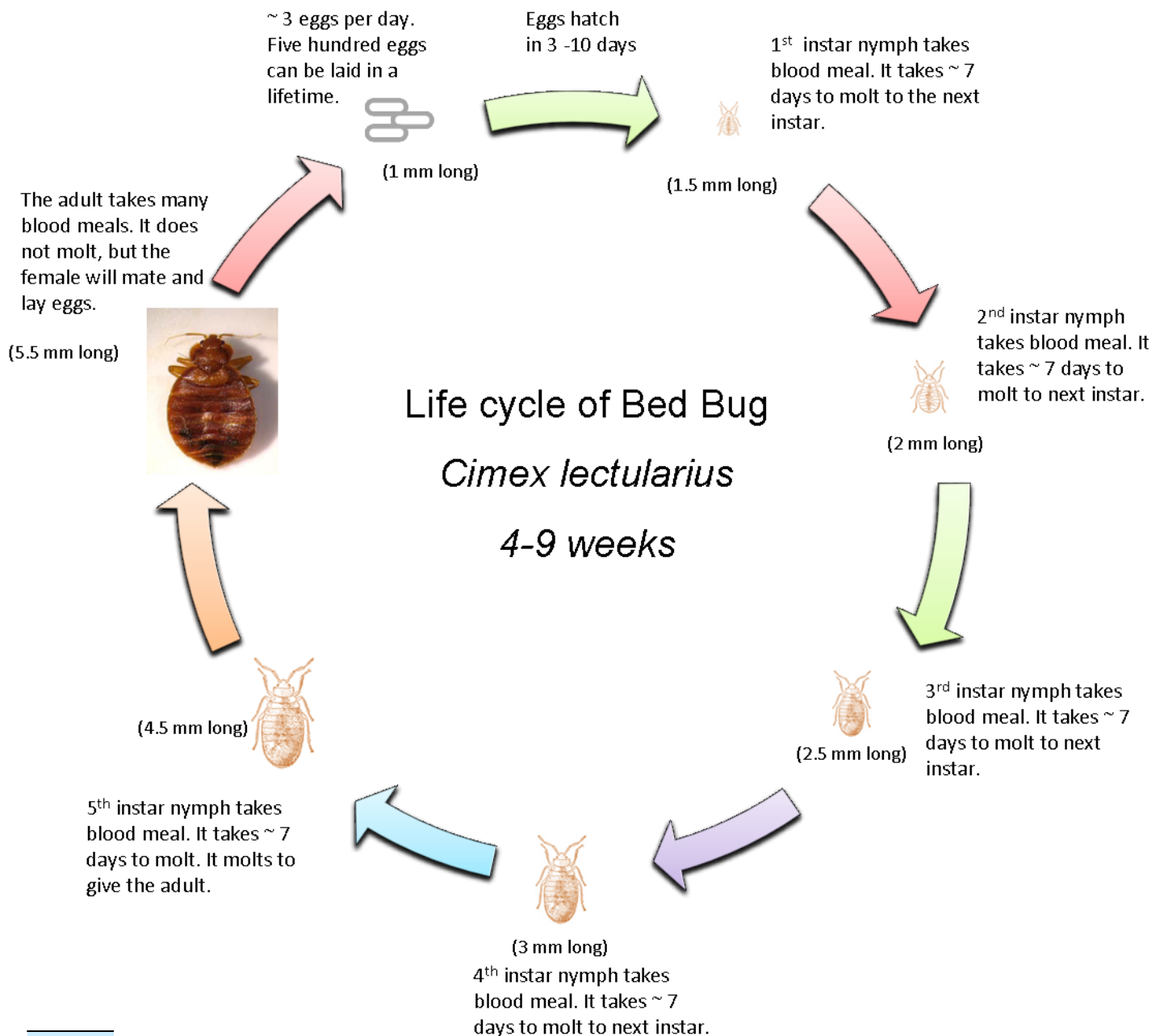

LIFE CYCLE PUZZLE

DIRECTIONS: Copy all tables as many times as needed, then cut out each square. Each student pair should have a copy of all 3 tables so they can put the life cycle together.

Table1. Stages of bed bugs







			
			BLANK SQUARE

Table2. Arrows to connect life cycle together

			
			4-9 weeks

<p>~ 3 eggs laid per day. Five hundred eggs can be laid in a life- time.</p>	<p>Eggs hatch in 3-10 days.</p>	<p>1st instar nymph takes blood meal. It takes ~7 days to molt to the next instar.</p>	<p>2nd instar nymph takes blood meal. It takes ~7 days to molt to the next instar.</p>
<p>3rd instar nymph takes blood meal. It takes ~7 days to molt to the next instar.</p>	<p>4th instar nymph takes blood meal. It takes ~7 days to molt to next instar.</p>	<p>5th instar nymph takes blood meal. It takes ~7 days to molt. It molts into the adult.</p>	<p>The adult takes many blood meals. It does not molt, but the female will mate and lay eggs.</p>

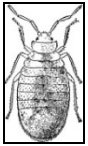
This is an example of what the finished life cycle should look like

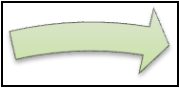
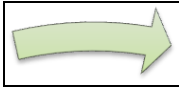
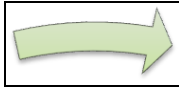
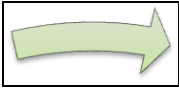
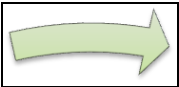
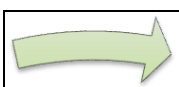
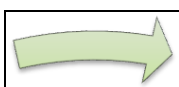
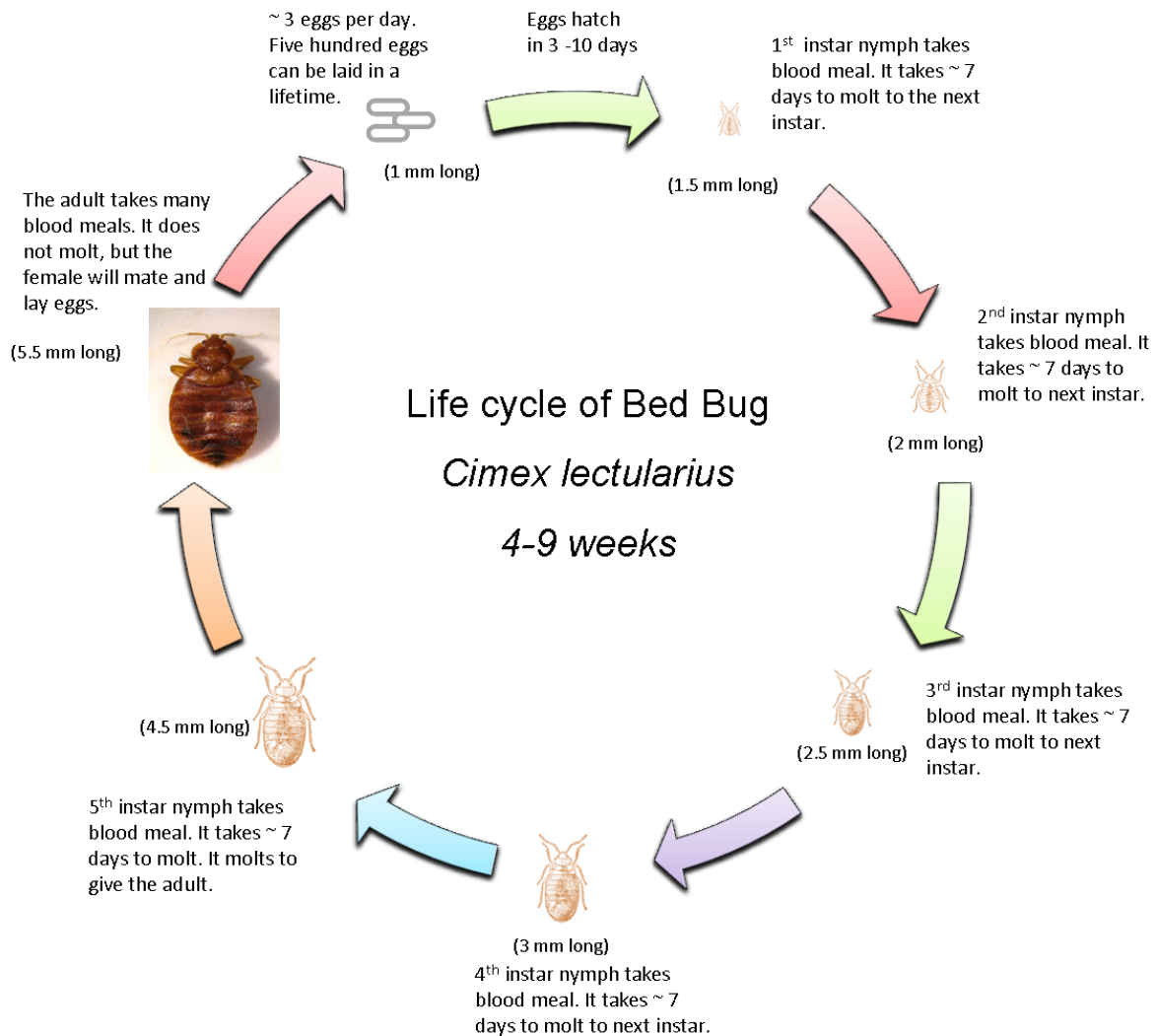

Bed Bug Symmetry

DIRECTIONS: Finish drawing the mirror image of the bed bug to give a complete picture.

Label the parts given below and then color it!

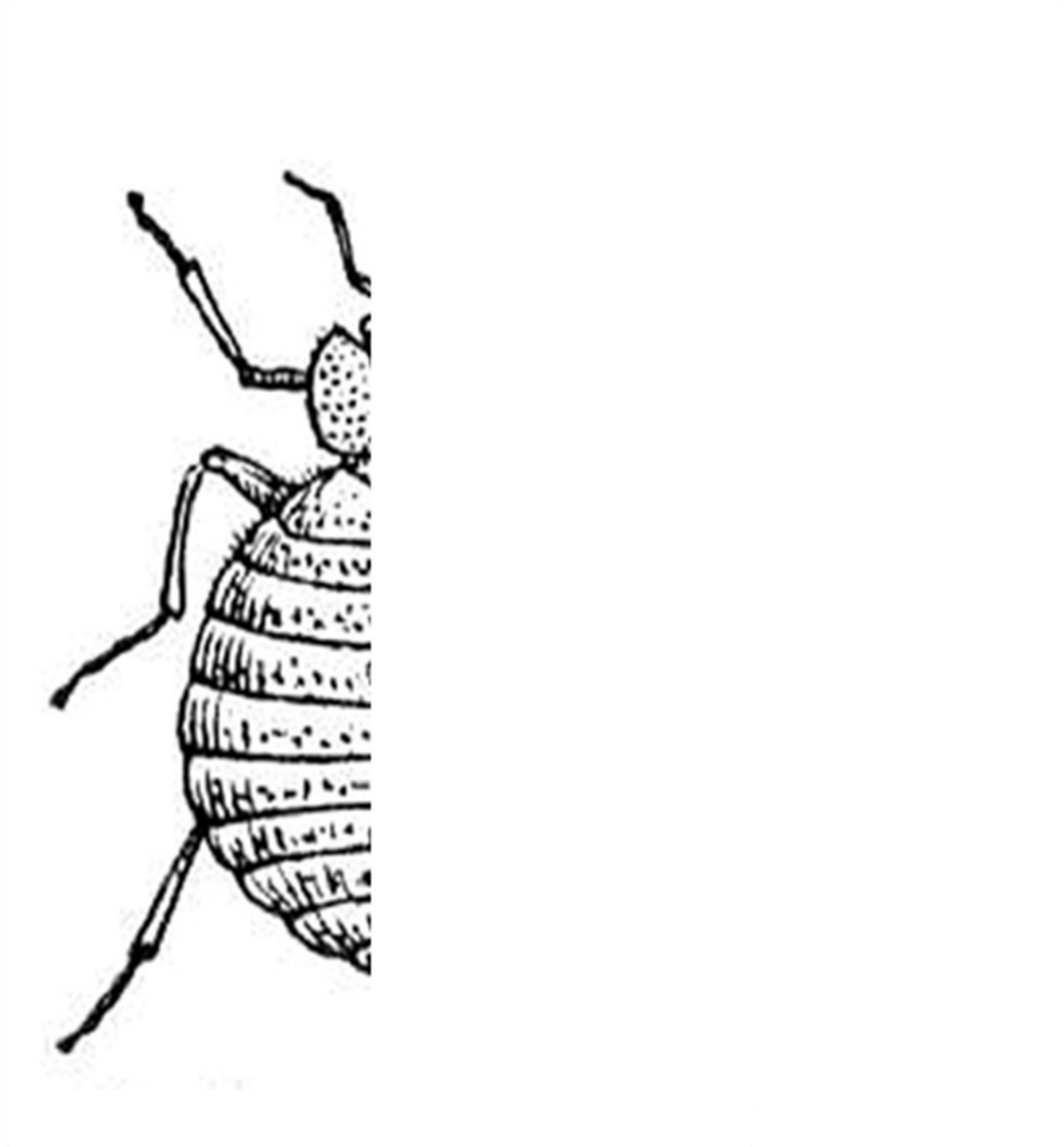

Label names: antenna, thorax, head, abdomen, wing pads, fore leg, hind leg, mid leg, compound eye

Bed Bug Symmetry

This is what the completed bed bug should look like. Students should then color it. (For e.g., brown or reddish brown).

DIRECTIONS: Finish drawing the mirror image of the bed bug to give a complete picture.

Label the parts given below and then color it !

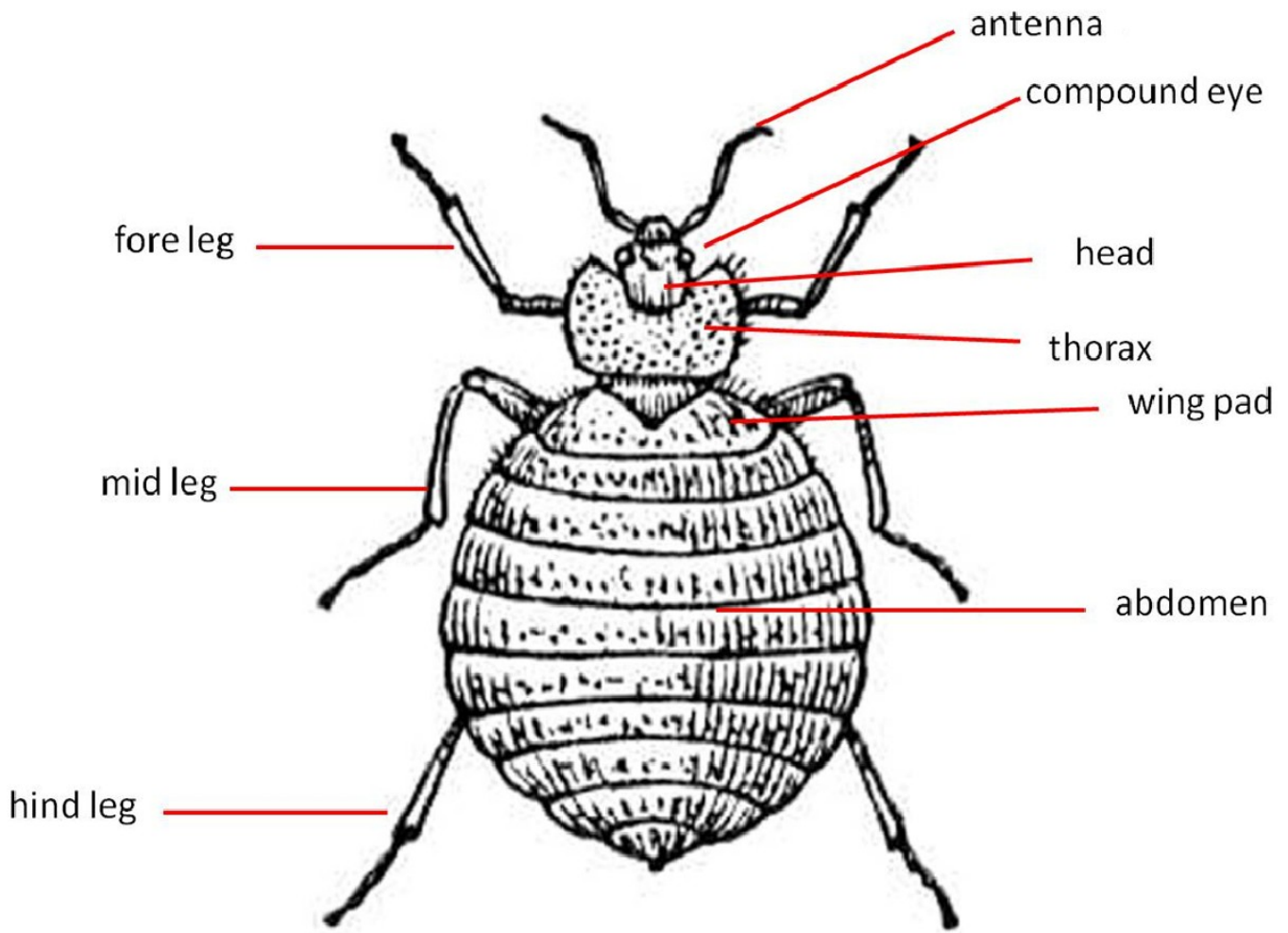

www.FreeKidsColoring.com

Bed Bug Game

KEY CONCEPT:

Students begin to understand language associated with bed bugs and personal hygiene and to relate their experiences through expression.

OBJECTIVES:

Students will be able to:

- Compare and contrast beneficial and pest insects
- Analyze effective strategies to prevent bed bug infestations using the given scenarios
- Demonstrate to others how to prevent bed bug infestations.

ACTIVITY INTRODUCTION:

Provide students access to a pinned insect collection. Insects may be obtained from a science teacher, local county extension office, local pest control company or collect them yourself! Depending on the number of insects provided in the collection, divide the students into that number of groups. Have the students examine the insects. Alternately, students could use photos of insects. Insect information and photos can be downloaded at http://entomology.ifas.ufl.edu/bug_club/index.shtml. After students view the insects, lay out the Bed Bug Game cards with the photos facing up and discuss the following questions.

Introduction:

1. Where would you find each of these insects (pinned specimens and insects in the photos)?
2. What do you think these insects eat?
3. Do these insects have adaptations that help them to survive?
4. Identify each insect as a pest, beneficial, or neither.

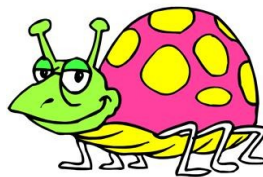

LEARNING CONCEPT:

- Self Concept

GRADE LEVEL: 3-5

SUBJECT: Health, Science

SETTING: Indoors; classroom with desks or tables

TIME NEEDED: 30-45 minutes

ENTOMOLOGY SKILL:

prevention

LIFE SKILL: Sharing, Teamwork, Leadership

SUNSHINE STATE STANDARDS:

HE.3.B.3.1, HE.3.P.1.1, HE.3.P.2.1
HE.4..P.1.2, HE.4.P.2.1, HE.4.B.3.1
HE.5.B.3.1, HE.5.P.1.2, HE.5.P.2.1

MATERIALS NEEDED:

Bed Bug Game Cards

Insect specimens

Pencil/pen and paper

TEACHER REVIEW:

Section 1.1 - Section 1.15

Let's Do:

1) Bed Bug Game

This game is based on the card game Old Maid and may be played in groups of two to eight players.

The Bed Bug Deck consists of 53 cards including 1 Bed Bug card.

Students should be divided into groups of two to eight players. One student is designated as the dealer. From the dealer's left, cards are handed out face down until all cards are distributed. Once all cards are distributed, players may view only their own cards. Any matches in the student's hand are discarded. Note that one student will have an extra card. Beginning with the person to the dealer's left, each player will offer their remaining cards face down to the player on their left. That person selects one card and sees if it matches one in his/her hand. If so, that player can lay down the match. If there is no match, the card is added to the player's hand and that player now offers their hand face down to the next player. Play continues in this fashion until only one player is left with a card, the Bed Bug Card. The person left with the bed bug card now must prevent the team from becoming infested. The card holder must give one piece of proper advice using the information they have learned from the bed bug lessons (for example, It's Getting Hot in Here) to each player on the team. If each player agrees that their advice is acceptable, then the card holder may rid him/herself of the Bed Bug Card by becoming the dealer in the next round.



Let's Reflect:

Have students that had the Bed Bug card raise their hands and ask each one to discuss a strategy for preventing a bed bug infestation.

Some answers may include: placing clothing and items in a high heat clothes dryer for one hour, inspecting for bloodspots on bedding and mattresses, inspecting hotel rooms and cabins for signs of bed bugs, having friends and family place their items in a plastic bin when they come to visit, observing insect bites and the pattern of those bites.

Let's Apply:

There are many arthropods that are classified as ectoparasites. Ectoparasites feed on the outside of a host. Some ectoparasites of humans include head lice, mosquitoes, ticks, chiggers (red bugs), fleas, and bed bugs. Have students work in groups to discuss the following situations and determine which arthropod is causing the bite symptoms. Each student should choose a character to investigate and then create a tri-fold information sheet about the pest that caused the symptoms for their character.

Situation 1: The Football Game

Last Friday, the football team had an away game. It was the home team versus the Snappers. It is now Monday and some students are experiencing some unusual symptoms. A class reporter has assembled the timeline of events for an article about the team victory. Read the reporter's notes and determine the likely cause of the itching for each of the students (cheerleader, quarterback, trombone player from the marching band).

Symptoms:

Cheerleader: Intense itching and small red bumps scattered around the ankles.

Football player: Red, itchy bumps on the back, arms, and legs. The red bumps seem to be in rows.

Band member: Red itchy bumps around the face, neck and arms.

Reporter's Notes:

The team, coaches and cheerleaders traveled on one bus while the band followed on another. When they all arrived at the stadium, the team and coaches went to the locker room, the cheerleaders went to a field across the road from the stadium to warm up, and the band unloaded their instruments and went to the stands.

Cheerleader Interview:

"It was a great game! Go team! I wish we had had a better place to practice before the game though. The grass on the practice field had not been mowed. Even with having to practice and walk through tall grass to get to the stadium, we had the best routine. I guess I reacted with the tall grass because now I have itchy bites all over my ankles. I don't know how I'll be able to focus this week with all this itching."

Determine the arthropod that likely caused the symptoms and explain why you suspect that arthropod.

Quarterback Interview:

"Man, thanks for supporting the team. We knew that the Snappers would be a tough team, but we were ready for them. Their locker room was a mess though. We barely had room to dress before the game. They had piles of old equipment, smelly uniforms, and dirty towels piled all over the benches and in the open lockers. We had to be careful that we didn't lose our uniforms in all the clutter. I must have been allergic to all that clutter because now I have red, itchy bumps in rows on my back, arms, and legs. I am glad they will travel to our field next year."

Trombone player Interview:

“I know Snappers live in swamps, but the bugs at the stadium were a bit much. The area under the stands was wet, so we really felt like we were in the swamp. It was hot and muggy, and we couldn’t focus on playing the fight song because we had to swat the little bloodsuckers every few seconds. The only relief we had was when we finally were able to get on the bus after our post-game field show. I have never been so happy to leave a game. On the way home I had lots of itchy bumps on my face and arms, but they have gone away now. Maybe I should keep some insect repellent in my instrument case.”

Situation 2: The Field Trip

Mrs. Williams’ fourth grade class just returned from a field trip to the Florida Museum of Natural History in Gainesville. The students worked hard to earn the field trip and were excited to go. On the bus ride back to the school, several students complained about bug bites. For the class yearbook, Erin wrote a summary of the trip. Read the story and determine which insects left the itchy bites.



“We are the green team!” Mrs. Williams’ class chanted as they loaded the bus. Rodrick had won the class t-shirt design and the class sported matching green shirts for their field trip to the museum. The students were excited to be visiting the museum and had worked hard all year to earn the privilege. With spirits running high, the girls in the class decided to braid each other’s hair during the bus ride to the museum. Emily had a brush and a bag of pony tail holders and ribbons, so she shared with the girls in the class. When the bus arrived at the museum, the students were placed in groups and were given permission to visit the Dog Agility Show that was taking place on the lawn next to the museum. Cacee and Corraine argued about what they wanted to do first, but Cacee won out and the group went to see the Frisbee catching dogs. Rodrick and Phil decided to visit the Butterfly Rainforest exhibit at the museum and Emily and Erin decided to head to the cave and Florida ecosystems display. After a couple of hours, the students met back at the picnic area to have lunch and discuss what they had seen. Emily and Erin couldn’t wait to tell Cacee and Corraine about the cute guy they met at the museum. He was a volunteer teaching visitors about insect pests. He had cockroaches that could pull toy tractors, and had a bed that showed where bed bugs may hide. After lunch, the group walked through the woods to get to the hotel on the other side of the museum. They stayed up all night playing games and talking about how much fun they had had. After returning to school, the students complained of bug bites and Cacee and Corraine shared what they had learned about bed bugs. Erin and Phil said it couldn’t be bed bugs because they had checked each hotel room and didn’t see anything.”

Determine the arthropod that likely caused the symptoms and explain why you suspect that arthropod.

Symptoms:

Emily, Erin, Corraine and Cacee - Itchy heads and red spots on their necks and behind their ears.

Corraine and Cacee - Itchy bumps on their calves and ankles.

Rodrick - One itchy red bump under his sock line.

Phil - No symptoms.

Have students design an informational brochure about the arthropod they have determined as the culprit in their situation. A piece of paper can be folded into thirds to create the public health information brochure. These brochures assess the level of knowledge of the pest and may be displayed in the classroom or on a bulletin board. The most detailed brochures, one from each pest, could be combined into a packet to be sent home with each student. Alternatively, students with the most detailed brochures could present their information to the class, to other classes, to parent-teacher groups, or to local clubs and organizations. This information could also be an addition to the school health fair.

Outside: Front Cover

Back

Inside Flap

<div data-bbox="418 1360 545 1430" style="border: 1px solid black; padding: 5px; text-align: center;">Title</div>	<div data-bbox="703 1360 865 1514" style="border: 1px solid black; padding: 5px; text-align: center;">Student Name</div>	<div data-bbox="1008 1360 1208 1430" style="border: 1px solid black; padding: 5px; text-align: center;">Illustration</div>
---	--	--

Inside:

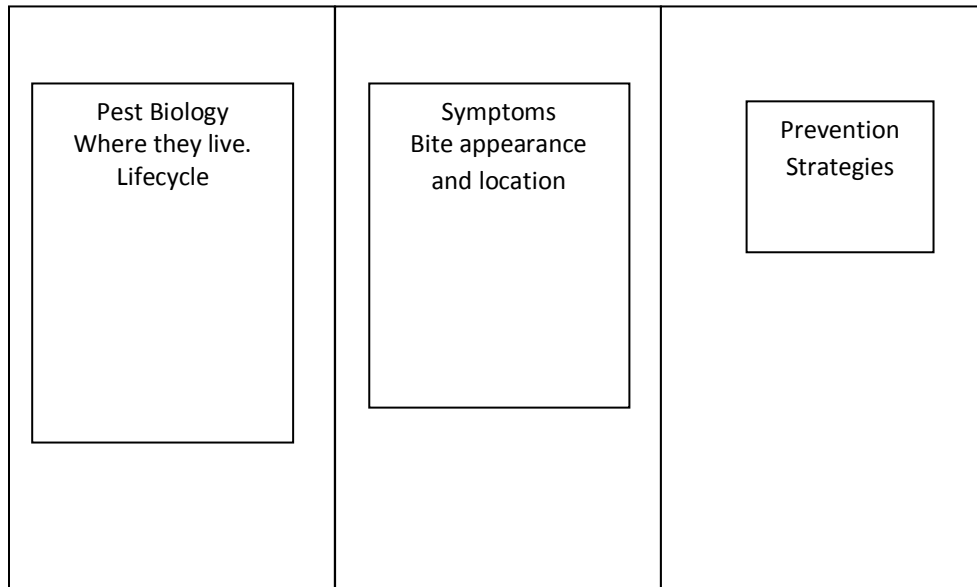

Answers:

Situation 1: Football Game

Cheerleader: chigger bites from the tall grass

Quarterback: bed bug bites from an infestation in the locker room

Trombone player: mosquito bites from the wet area near the stands

Situation 2: Field Trip

Emily, Erin, Corraine and Cacee: head lice bites from sharing hair brushes and accessories

Corraine and Cacee: flea bites from standing near the dogs at the agility competition

Rodrick: tick bite from the woodland walk

Discussion:

Anyone can get bed bugs. If a student suspects they may have bed bugs they should inform an adult so action can be taken.

Extension:

Act out a scenario for another class or parent group.

Create puppets for the characters and arthropods.

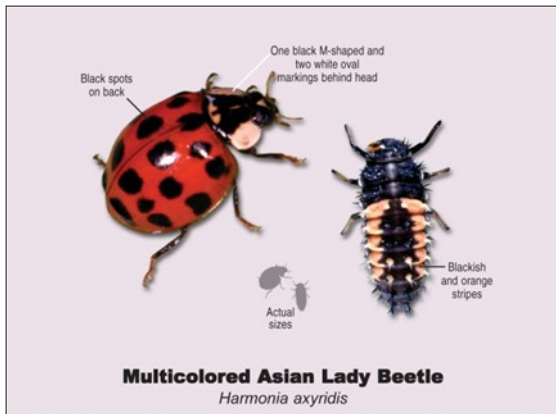

Lady beetles feed on aphids and scale insects. They come in many colors, ranging from dark red to mustard yellow and generally, but not always, have black spots on their wing covers. Notice the larva is orange and black and has an alligator shape

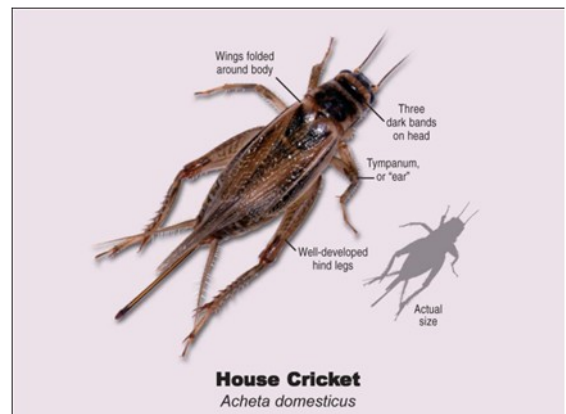

Crickets are nocturnal and normally live outdoors, preferring warm weather. They will move indoors when temperatures drop. They hide in cracks and crevices, as well as, behind baseboards. Males chirp to attract females and repel other males.

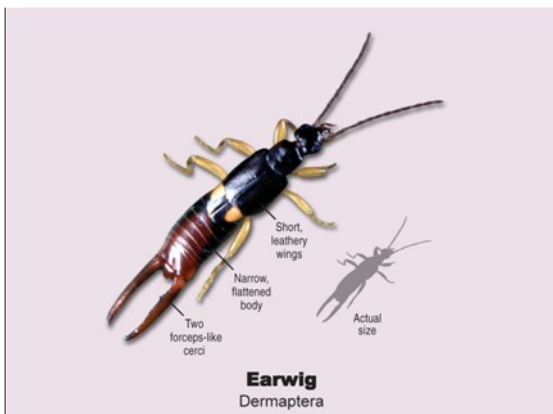

Earwigs are active at night, and are often attracted to lights. During the day, they hide under stones, logs, sidewalks and leaf litter. They can be easily identified by their two forceps-like appendages at the end of their abdomen.

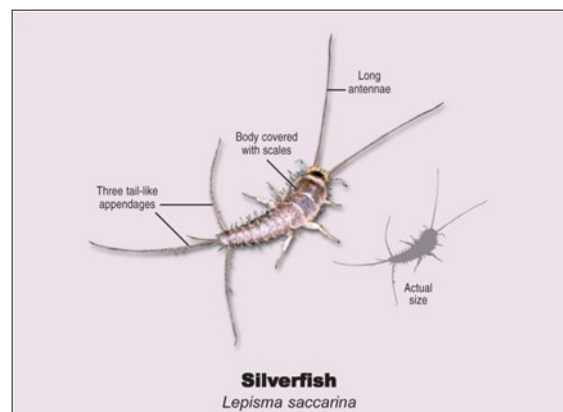

Silverfish are small and can hide inside cracks and crevices. They can be identified by the gray scales along the body and three long, tail-like appendages. They feed on books, papers, wallpaper paste, mold and fungi and can live for two to three and a half years.

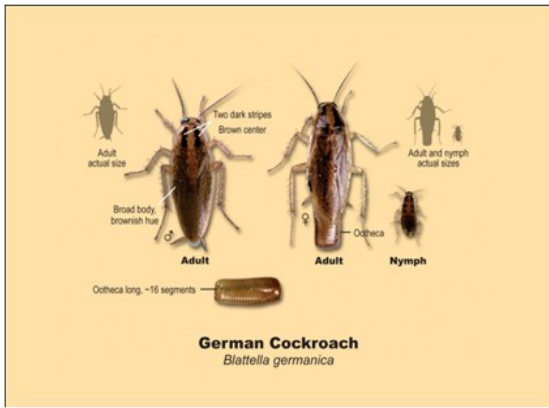

The German cockroach lives indoors in close association with people. It prefers to live in kitchens and bathrooms of homes and apartments, restaurants, supermarkets and hospitals. This is the most important species of cockroach in the United States.

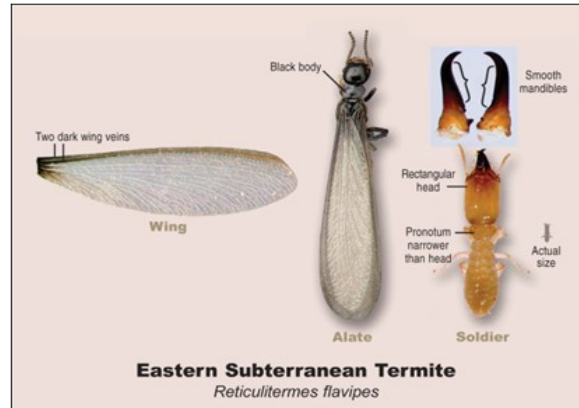

Termites are found underground and in wood. Workers construct mud tubes to move from one location to another, but reproductive adults will swarm to start new colonies.

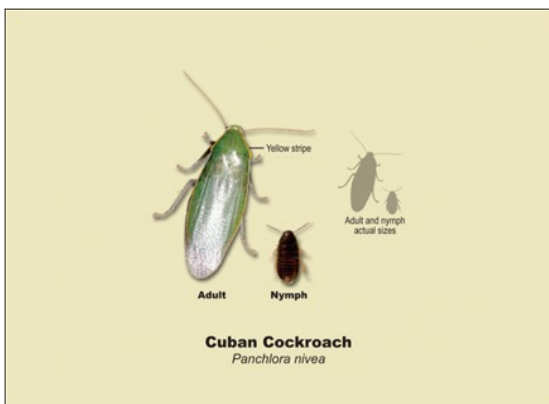

The Cuban cockroach is an outdoor, tropical species that usually is not found north of Florida. The adults are pale-green, whereas the nymphs are dark brown. Adults are attracted to lights.



Black widow spiders are abundant in many habitats, but often are found under overhangs, in garages, and in woodpiles. Although they are highly prevalent, black widows are not aggressive and rarely bite. The bite of the black widow contains a neurotoxin that can be very dangerous to the young and the old.

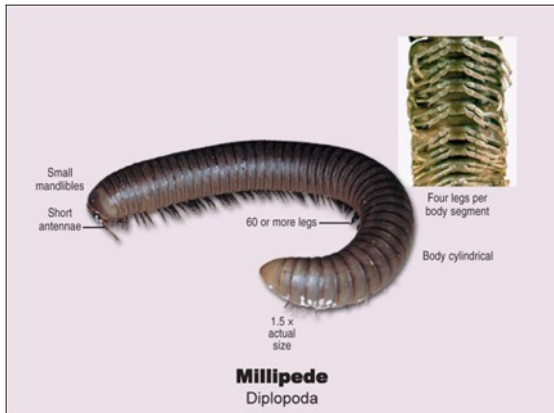

Millipedes normally live outdoors in leaf litter and use piles of organic matter as harborage. They resemble centipedes, but can be identified by the four legs (two pairs) per body segment. They feed on damp and decaying wood as well as vegetable matter.



Bottle flies are found near fresh carcasses, road-kill, rotting vegetation, animal feces, garbage dumps, and meat wastes. Blow flies lay their eggs on fresh carrion (dead animals) and are among the first insects to colonize a body once it has died.

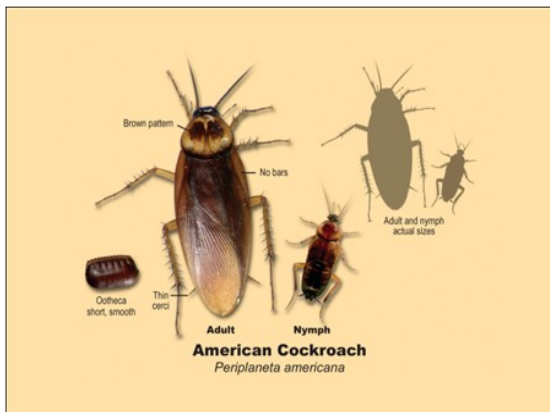

The American cockroach is associated with moist areas and is commonly found in sewers and basements. It is also commonly found in homes, factories, hospitals and zoos.



This cockroach is commonly found in leaf mulch, wood piles and under rotting logs. It is often referred to as a palmetto bug, but may be called the stinking cockroach because it produces a foul-smelling fluid to protect it from predation.

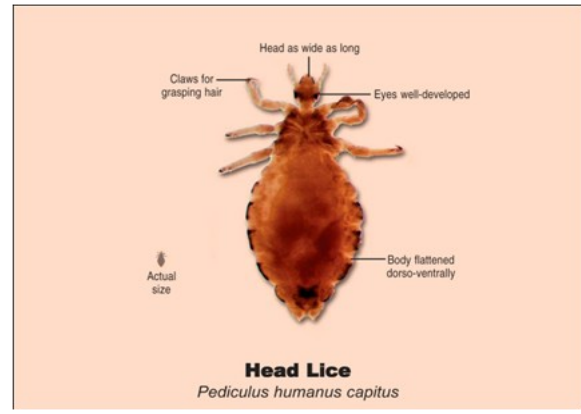

The brown dog tick is the most important tick in and around houses. It feeds on mammals including humans, deer, rodents, and especially dogs. Ticks must feed on blood to develop.

Found almost exclusively on the head of the human hosts. Requires a blood meal once or twice a day. They are passed from person to person mainly via head-to-head contact, but may be transmitted by sharing combs, hats, or other personal items that contact hair. They die in 24-72 hours if off of the host.

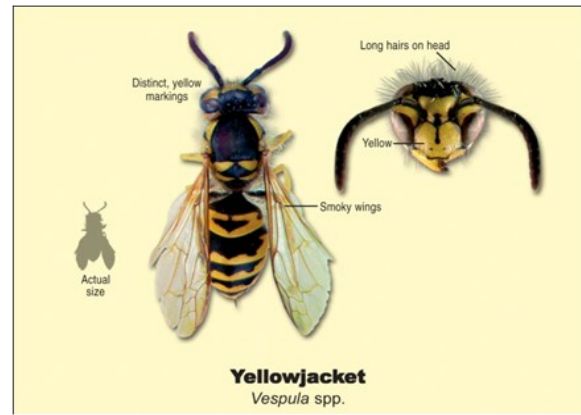
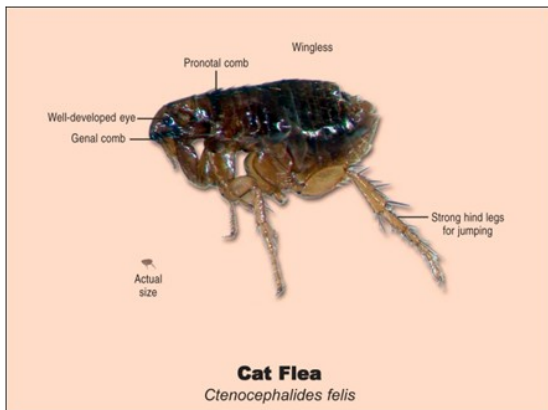

Fleas are found on are around their host (usually cats, dogs, humans, livestock or wildlife). Both males and females require a blood meal, but females must have blood to produce eggs.

Yellow jackets feed upon insects, especially caterpillars, and also feed on nectar. Females feed chewed-up caterpillars to their larvae. Female adults sting if they feel the nest is threatened. Nests are often constructed underground.

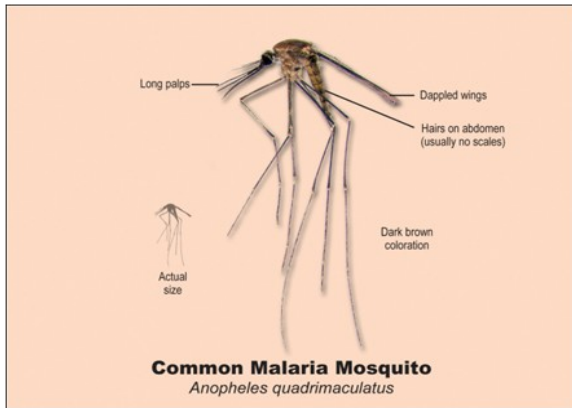

Adults fly at dusk and dawn and females seek a blood meal so she can lay eggs. Hosts include mammals and birds.

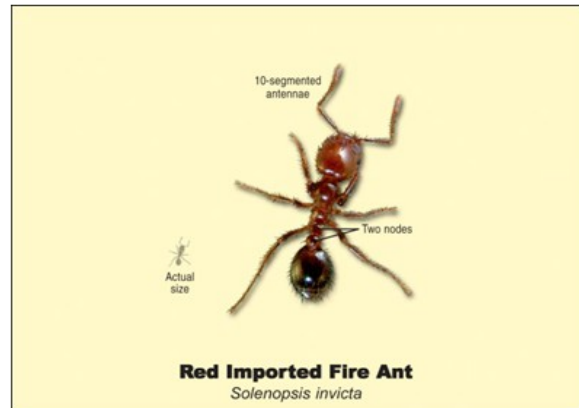

Red imported fire ants feed on sweets, fats, and proteins. They feed upon living and dead insects and animals. Foraging ants form tightly linked trails. Workers are extremely aggressive when the nest is disturbed, and will readily sting.

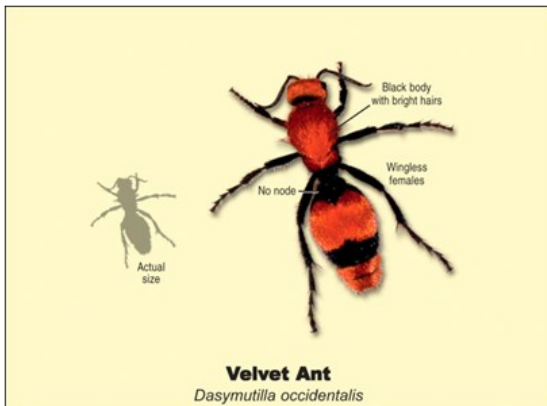

Velvet ants are not actually ants, but wasps. Females are wingless and covered with patches of dense, often brightly colored hair. Velvet ants are parasitic upon wasp larvae. The females have an extremely painful sting, but they sting only if handled.

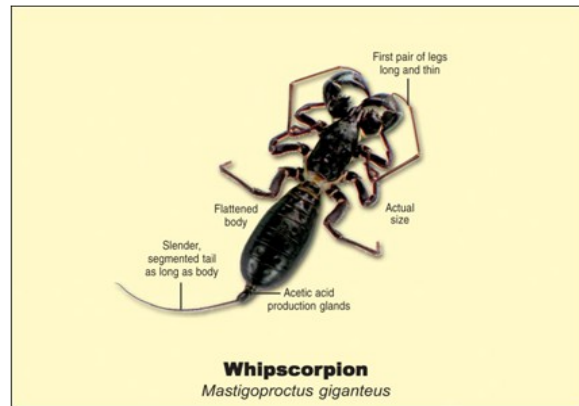

Whip scorpions are nocturnal hunters that burrow in sandy soil. Although they are not aggressive, adults can pinch, and they secrete concentrated acetic acid through scent glands. They are insectivorous.

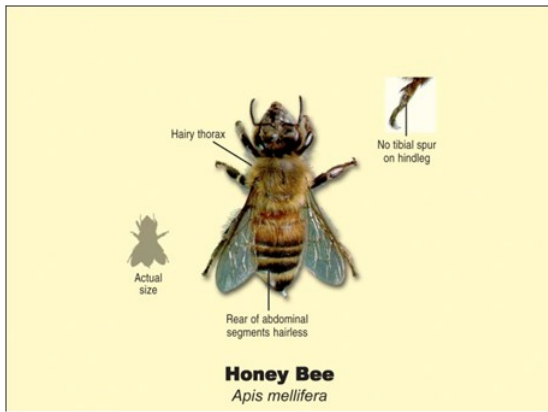

Honey bees feed on nectar and produce wax and honey in their nest. Honey bees are beneficial insects, and control is often unwarranted. Feral colonies of honey bees construct their nests from trees and, often, within wall voids in structures.

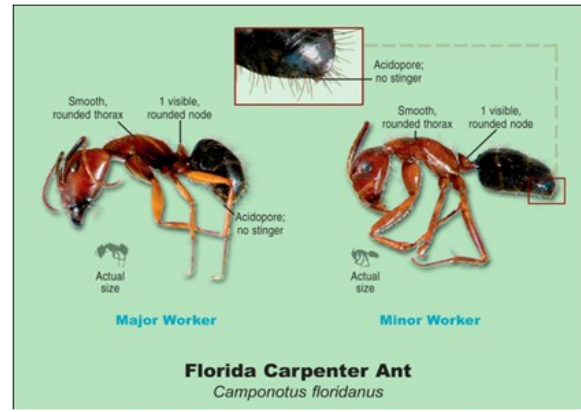

Carpenter ants excavate wood for a nesting site, but do not consume it. They are typically found in stumps and dead logs. Workers are nocturnal and forage for sugar and insects. The ants bite with powerful jaws and may spray formic acid into the bite causing a burning sensation.

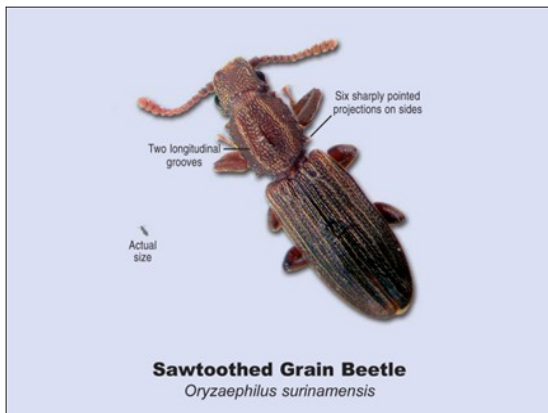

The saw-toothed grain beetle is a stored product pest that damages grains. It attacks many items including cereal, bread, breakfast foods, macaroni, dried fruit, nuts, sugar, chocolate, dried meat, candy bars, drugs, tobacco, and snuff.

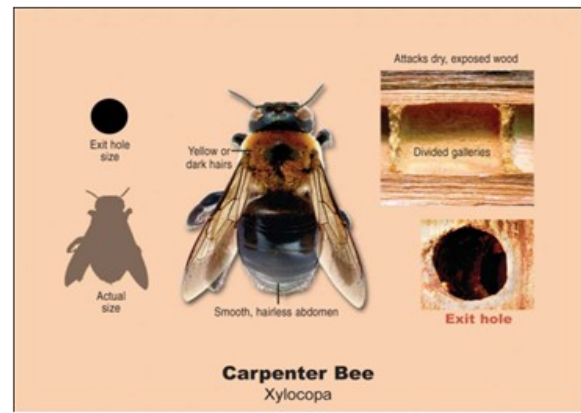

Females carpenter bees prefer to excavate nest tunnels in exposed, unfinished wood. They overwinter in old nest tunnels and create new tunnels in the spring. They rarely sting.



Spider beetles feed on both plant and animal materials such as broken grain, grain products, seeds, dried fruits and meats, wool, hair, feathers, drugs, and plant and animal museum specimens. They are associated with poor sanitation.

Crazy ants nest under concrete slabs, in floors, wall voids, and under plants. Foragers prefer sweets, but also feed on insects and seeds. They do not strongly follow trails, so have a “crazy” pattern of movement.

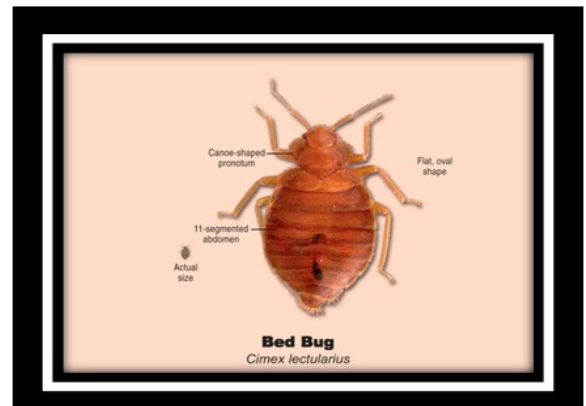
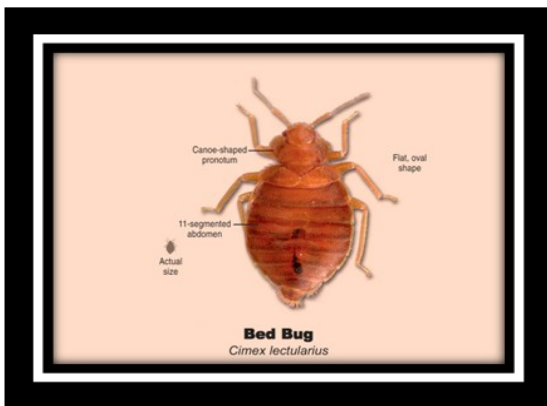

Bed bugs live in urban environments in cracks of structures. They are great hitchhikers and can be picked up in almost any urban location. They typically feed at night and prefer to feed on humans. Although they bite and feed on blood, they are not known to transmit disease.

Bed bugs live in urban environments in cracks of structures. They are great hitchhikers and can be picked up in almost any urban location. They typically feed at night and prefer to feed on humans. Although they bite and feed on blood, they are not known to transmit disease.

Starring Bed Bugs

KEY CONCEPT:

- Through their imagination students express their ideas, thoughts, and fears associated with their experiences of bed bug infestations.
- Students are empowered by learning that they have some control over their bodies and the health of their bodies.

OBJECTIVES:

Students will be able to:

- Relate cultural dances to the impact of arthropods on humans.
- Illustrate pest insects and their management strategies in the form of a comic strip.
- Discuss bed bug management strategies.

ACTIVITY INTRODUCTION:

Read the history of the Italian folk dance the Tarantella.

As early as the 14th century (1300s), there was a custom in the region of Taranto, Italy, where victims of a spider bite had to dance in order to counteract the spider venom. Those bitten suffered pain, muscle cramps and nausea, so it was believed that sweating would get the poison out. Musicians would even walk the fields seeking victims who would pay them to play music for them as they danced. The thought was that to counteract the venom, the victim had to dance for hours or even days. This custom continued for over 300 years, and the fast musical style, usually in 6/8 time, with tambourine, accordion, guitar, flute and drums has become a folk dance. Great composers have used this traditional musical rhythm in their music and ballets. Some of these great composers include Chopin, Debussy, Liszt, Mendelssohn, Rachmaninoff, Rossini, Saint-Saëns, Tchaikovsky, and Schubert to name a few. These famous musical pieces are still performed today and adaptations of these songs can be found in modern film and video game scores.

LEARNING CONCEPT:

- Creativity
- Self Concept

GRADE LEVEL: 3-5

SUBJECT: Health, Science

SETTING: Indoors; classroom with desks or tables

TIME NEEDED: 30-45 minutes

ENTOMOLOGY SKILL:

LIFE SKILL: Creativity

SUNSHINE STATE

STANDARDS:

HE.3.P.2.1, HE.3.C.2.1, HE.3.C.2.2, HE.3.C.2.3
HE.4.P.2.1, HE.4.P.1.1
HE.5.C.2.1, HE.5.P.2.1

MATERIALS NEEDED:

Paper
Colored Pencils
Examples of Tarantella music

TEACHER REVIEW:

Section 1.1 - 1.15

Examples of Tarantella music can be found at:

PIANO:

- Tarantella, Venezia e Napoli by Liszt performed by George Li in NY 2010. http://www.youtube.com/watch?v=BExvhde_gJE
- Tarantella, Op. 102, No. 3 by Mendelssohn performed by Theo Yoch in CA 2009. http://www.youtube.com/watch?v=OXllqqQs_bQ
- Danse Tarantelle styrienne by Dubussy performed by a faculty member at the SC Governor's School for the Art and Humanities 2010. <http://www.youtube.com/watch?v=JZbXTMiOWfo>









More Examples of Tarantella music can be found at:

ACCORDIAN:
<http://www.youtube.com/watch?v=qMM546Axd7M>

FREE SHEET MUSIC:
http://www.makingmusicfun.net/pdf/sheet_music/tarantella-piano.pdf

Let's Do:

- Discuss the tarantula folk dance and the story behind the dance. Have the students make a list of symptoms they might experience if they were bitten by bed bugs. Have students write a TV or video game theme song, dance, poem, or song about bed bugs. Remember that the music must be a quick tempo and should include a lot of movement. Students may even want to make instruments out of cans and dried beans, pots and wooden spoons, paper plates and bells, etc. Samples of Tarantella music may be found online.

 <p style="text-align: center;">Lava Man with steam power</p> 	<p style="display: flex; justify-content: space-around;">Bloodspots Bed Bugs</p> <div style="display: flex; justify-content: space-around;">   </div> <p style="text-align: center;">Used Bunk Beds</p>  <p style="text-align: center;"><i>HELP!</i> <i>Lava man, please use your heat to take care of the bugs.</i></p>	<p style="text-align: center;">Steam the furniture. Kill the bugs.</p>    <p style="text-align: center;">Happy family Thanks Lava Man!</p>
--	--	---

Let's Reflect:

When assessing the students' knowledge of bed bug management, have students share their creative works with the group. The most creative stories, comics, or songs could be presented to a school/community or PTA group.

How are biting arthropods portrayed in history?

What cultures use dance as a form of expression?

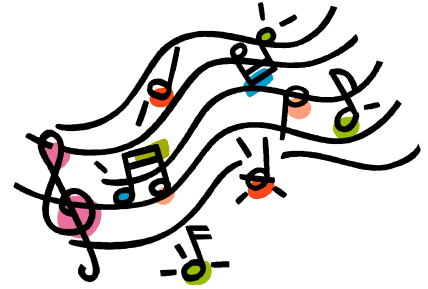

Let's Apply:

As you relate the creative works with a real life application you may want to discuss the following questions.

What are bed bugs and where do they live?

What do their mouthparts look like and what symptoms do people have when they have been bitten?

Bed bugs have piercing-sucking mouthparts (Activity– Eat Like a Bug)

What do the bites look like?

Bites are in rows and can resemble mosquito bites (BUT NOT ALWAYS).

How do bed bugs move (crawling versus jumping or flying)?

Bed bugs cannot fly or jump, only crawl.

Why might people be afraid of bed bugs?

Do you think a bed bug dance will become part of our culture?

Will bed bugs hurt people?

Bed bugs cannot transmit diseases to people; however, some people become afraid to sleep at night.

What can you do to help others manage their bed bug problem?

Present your comic strip or dance to a group, such as another class or the PTA to help raise awareness about bed bugs.

Feelings Finder

KEY CONCEPTS:

- Students begin to understand their role and that of their parents/ caregivers in the control and prevention of bed bug infestations.
- Through their imaginations children express their ideas, thoughts, and fears associated with experiencing bed bug infestations.

OBJECTIVES:

Students will be able to:

- Understand the role of bed bugs as serious nuisance pests.
- Identify with others about how they feel about bed bugs.
- Meet professionals within their community who will talk about how bed bugs impact their jobs.
- Know the difference between an introduction vs. infestation of bed bugs.

ACTIVITY INTRODUCTION:

In this learning session, students will be expressing their views about bed bugs and relating to others who may have had bed bugs. Encourage open communication with students, but also be sure to let students know that no one should be ashamed if they have had an experience with bed bugs because any one can get bed bugs.

Let's Do:

- Have students do the writing activity "Imagine if you had bed bugs"
- After writing, encourage children to share what they wrote. Help them to identify their own and other people's feeling at different times and under different circumstances.
- Discuss the term **delusory parasitosis** with students. Help students share how they think people would feel if they think that they are being bitten when they are not.
- Discuss that bed bugs are a community problem because anyone can get bed bugs and they move on clothes and bags. Discuss the term **infestation** vs. **introduction**.
- Invite representatives from various community services or the pest control industry to explain the helpful role they play in the community as it relates to bed bugs.

LEARNING CONCEPTS:

- Creativity
- Social Development

GRADE LEVEL: 3-5

SUBJECT: Health, Science,

SETTING: Indoors; classroom with desks or tables

TIME NEEDED: 30-45 minutes

LIFE SKILL: open communication

SUNSHINE STATE

STANDARDS:

HE.3.B.2.1, HE.3.C.2.7, HE.C.3.1.2
HE.4.C.1.2, HE.4.C.2.2, HE.C.4.2.3,
HE.4.B.2.1,
HE.5.C.2.3, HE.5.C.1.2, HE.5.B.2.1,
HE.5.C.2.2

MATERIALS NEEDED:

Pencils

Copies of "Imagine if you had bed bugs" for each student

VOCABULARY:

delusory parasitosis, infestation, introduction

TEACHER REVIEW:

Section 1.1
Section 1.7
Section 1.10
Section 1.11
Section 1.12

Let's Reflect:

How would you feel if you had bed bugs?

What would you say to your friends who may have bed bugs?

Explain that it is okay if they have bed bugs and that it is okay to ask a friend to put their stuff in a plastic bin if they come over to play so that the bed bugs are not transferred. Accept comments from students.

Do you think that bed bugs can be in homes, movie theaters, buses, airplanes, or schools? How do you think that they get there? What do you think your role as a kid is in helping prevent bed bug spread?

Let's Apply:

Explain to students that they should always be considerate of each other's feelings, especially if they have had an experience with bed bugs.

Do students personally know someone who had bed bugs? (Neighbor, friend, family member)? How did they react when they heard?

If someone treats you differently because they know you have bed bugs, how would you handle that situation? How can you educate them?

Notes:



VOCABULARY:

Delusory parasitosis: When a person believes that there is an insect or some other organism that is biting or crawling on them, when in fact, this is not true.

Infestation: A situation where all stages of bed bugs are found in a given location.

Introduction: A situation where bed bugs are transported into an uninfested area.

IMAGINE IF YOU HAD BED BUGS!

Write a short story explaining how you would feel if you had bed bugs. What would you say to your parents/friends? What could you do to get rid of the bed bugs?



Healthy Hands Have Healthy Homes

KEY CONCEPT:

- Students begin to understand their role and that of their parents/ caregivers in the control and prevention of bed bug infestations.

OBJECTIVES:

Students will be able to:

- Determine potential harborage sites for bed bugs at home and in the classroom.
- Recognize the importance of maintaining a healthy environment.



ACTIVITY INTRODUCTION:

It is important that students understand that they have control over their own health. This activity will help engage the students in the classroom and at home to examine their environments and determine how they can assist in reducing the risk of bed bug infestations.

Let's Do:

This activity has variations that can be done in the classroom, at home, or both for a complete understanding of the student's surroundings.

In the Classroom:

Place colored confetti or pieces of punched out paper to represent bed bugs around the room. Bed bugs like to live in tight confined areas that are dark. Some locations to place the "bed bugs" are: cracks of desks, coats, book bags, bookshelves, along baseboards, along picture edges, etc.

With the students sitting at their desks, have them write down where they think the bed bugs might be hiding. Encourage them to be as quiet as possible and really think. Once an allotted time is up (5-10 minutes) have a student one by one check the area they wrote down to see if the bed bugs are where they thought they were hiding. Whoever finds the most bed bugs is the Star Inspector for the Day. Another version would be to have the students walk around the room instead of sit at their desks and try and locate the bed bugs.

LEARNING CONCEPT:

- Social Development

GRADE LEVEL: 3-5

SUBJECT: Health, Science

SETTING: Indoors; classroom with desks or tables

TIME NEEDED: 30-45 minutes

ENTOMOLOGY SKILL: prevention

LIFE SKILL: taking control of their health situations

SUNSHINE STATE STANDARDS:

HE.3.B.2.4, HE.3.B.3.2, HE.3.B.4.1, HE.3.P.1.2, HE.4.C.1.3, E.4.C.2.1, HE.4.P.1.1, HE.4.P.1.3, HE.4.B.3.2, HE.4.B.4.1, HE.4.B.2.4, HE.5.B.2.4, HE.5.B.3.2, HE.5.B.4.1, HE.5.P.1.3

MATERIALS NEEDED:

Copy of activity sheet for each student

Confetti or paper hole punches

TEACHER REVIEW:

Section 1.10 - Section 1.15

Let's Do:

At Home:

Provide students with the activity sheet “*Bed Bug Hunt*” to complete at home. Students should return with their sheets the next day to go over their answers.



Let's Reflect:

Why is it important to keep our dirty clothes off the floor?

Bed bugs like to hide in clothes and can be spread to school if we wear a jacket or piece of clothing that was on the floor with other clothes that had bed bugs.

You checked between your mattress, but bed bugs don't only live near beds. Where else do you think they might be at your house?

Students should have identified several locations including closets, furniture, baseboards, popcorn ceilings, etc., as potential harborage sites. Borrowed or used furniture is a great way to introduce bed bugs into a home.

If you found crumbs in the couch, would a bed bug eat those?

Bed bugs only feed on blood. They may be in the couch, though, waiting for someone to sit a while.

If you think you found bed bugs at home who should you tell? What if you think you saw them on the bus or at school?

Students should be encouraged to tell parents/guardians if they think they see bed bugs at home. If a student sees them on the bus or at school, they should notify a teacher or administrator.

Let's Apply:

Have students brainstorm what they can do in the classroom and at home to help reduce the risk of bed bugs. Some answers might be:

- Get clear plastic bins to put book bags and jackets in at school or at home when a friend comes over
- Help with chores to make sure the house stays clean
- Help with laundry
- Keep their rooms clean
- Regularly look for bed bugs

Challenge students to pick one thing off of the list and do it for two weeks. Ask them to journal about it, how it makes them feel to help at home or in the classroom, and if it would be something they would continue.

Bed Bug Hunt



NAME: _____

Count how many pieces of dirty clothes are on the floor of your bedroom. _____

Check between your mattress and your box springs; do you see any smears, spots, or bugs? _____

Look in the couch behind the cushions; what did you find? _____

If you found crumbs, will a bed bug eat these? _____

What might eat them? _____

Look through your book bag, check the insides and bottom; what did you find? Any bed bugs?

Locate the best places in your room a bed bug might hide. What are they? Hint: bed bugs like dark, cramped areas

Check the areas you identified in the previous question; what did you find?

List what you do at home to help keep the house clean:

Why is this important? _____



Who would you tell if you think you found bed bugs at home? What about on the bus or at school?

High Tech Bed Bugs

KEY CONCEPT:

Children participate in exploring, designing, and creating ways to control and help prevent bed bugs.

OBJECTIVES:

Students will be able to:

- Recognize the influence media plays in public health issues.

ACTIVITY INTRODUCTION:

The media can influence everything from how we live to how we think. Students need to be able to recognize different types of media, how media may influence their opinions, and how it can be used to provide different forms of information.

Let's Do:

Using sources such as newspapers, internet sources like You-Tube, local news, advertisements, and radio, have students find five media stories that have happened in recent times on bed bugs and present to class.

Use the *Bed Bug Technology Wheel* to gather students' comments and thoughts about each media area. Focus on what they found, if the information is credible, and how easy was it to access. Questions to guide the discussion are found on the activity sheet.

Adaptation: To help students focus have students write a question about bed bugs they want to answer on a sticky note or on the board. Have them try and answer that question while they are doing their research.

LEARNING CONCEPT:

- Technology

GRADE LEVEL: 3-5

SUBJECT: Health, Science

SETTING: Indoors; classroom with desks or tables

TIME NEEDED: 30-45 minutes

LIFE SKILL: recognizing the influence of the media on society

SUNSHINE STATE STANDARDS:

HE.3.B.1.4, HE.3.B.1.1, HE.3.C.2.5, HE.3.C.2.6

HE.4.B.1.1, HE.4.B.1.4, HE.4.C.2.5, HE.4.C.2.6

HE.5.B.1.1, HE.5.B.1.3, HE.5.B.1.4, HE.5.C.2.5, HE.5.C.2.6

MATERIALS NEEDED:

Sticky notes

TEACHER REVIEW:

Section 1.1 - 1.15



Let's Reflect:

Is the media influence positive or negative against bed bugs?

Use the *Bed Bug Technology Wheel* to reflect on what they found.

Let's Apply:

Compare bed bugs in the news to other current events and types of media and discuss the importance of both.

How do the stories they found about bed bugs influence their lives?

Do students feel bed bugs are as great a problem as the media may make it seem?

Can you trust everything you see or hear through the media? How do you know if something is true?

Notes:



EXTENSION:

Have students act out or create their own media stories about bed bugs and create a media piece to share with the class.

Bed Bug Technology Wheel

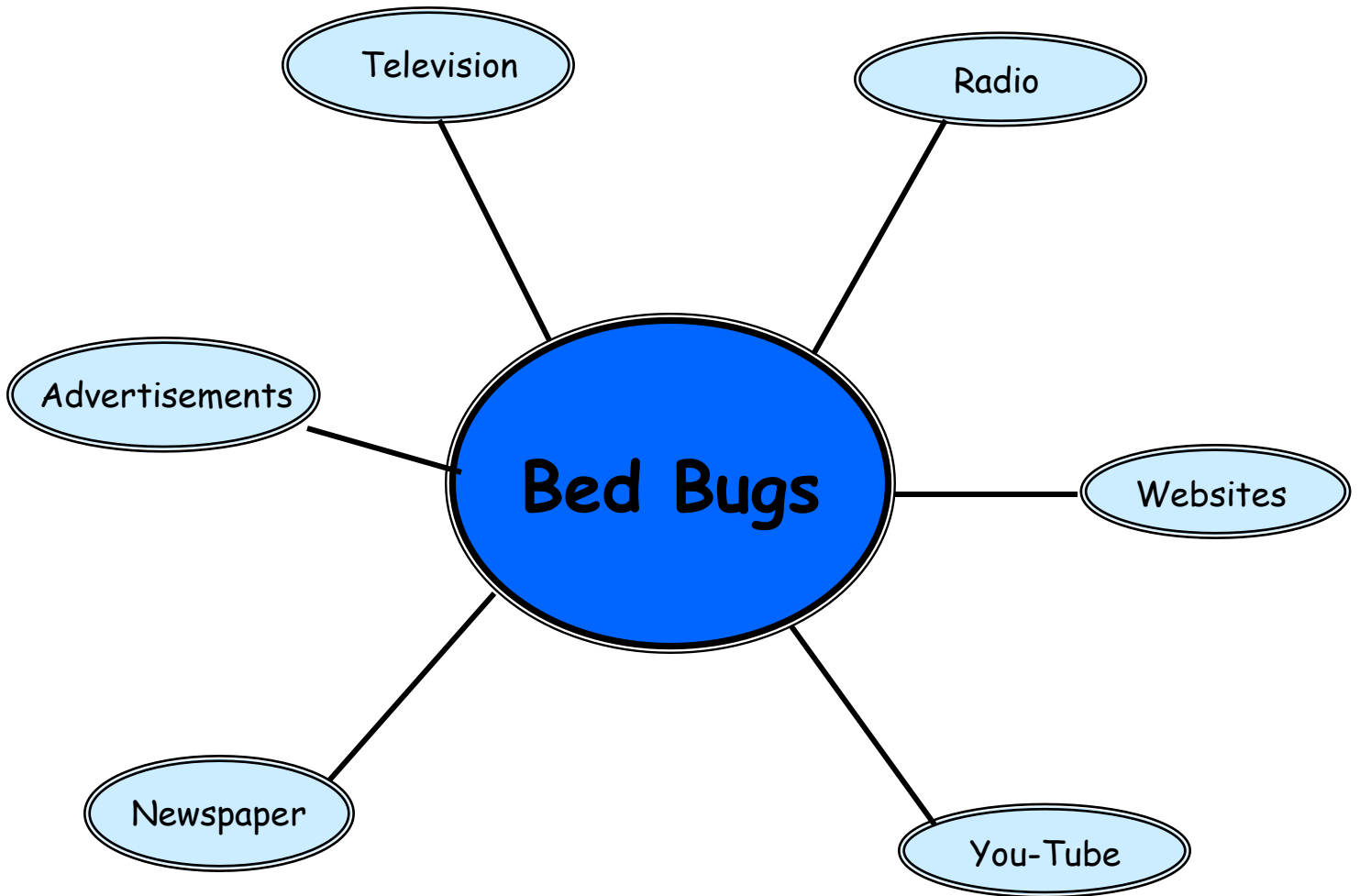

For each area indicate:

- How easy was the information to access?
- Estimate how credible the sources of information were?
- Was it educational or a human piece?
- Was it positive or negative towards bed bugs?
- How did each media piece (article, video, or website) make them feel about bed bugs?
- Which media did they learn the most about bed bugs from?

It's Getting Hot in Here!

KEY CONCEPT:

Children participate in exploring, designing, and creating ways to control and help prevent bed bugs.

OBJECTIVES:

Students will be able to:

- Learn what can be done to remove bed bugs from their personal belongings.

ACTIVITY INTRODUCTION:

Bed bugs can be carried on personal belongings or even on your body. You can carry bed bugs home from school in your belongings or you can carry them from an infested home to school. Sometimes you may even get bed bugs from your neighbors on the bus. You need to make sure you do not carry and spread bed bugs from one place to another. Here are some ways to stop the spread of bed bugs on personal belongings :

1. Bed bugs cannot stand hot temperatures. They do not survive hot temperatures and die in 1 minute at 120° F.
2. Bed bugs cannot hold onto furniture, walls, or floors when sucked by a vacuum cleaner, but eggs can be glued onto surfaces. Vacuum cleaners will suck bed bugs up, but will leave most eggs behind.
3. Bed bugs can survive in a freezer for a long time (more than 5 days), but they cannot move when cold.
4. Bed bugs can be washed off your body or clothing. Taking a shower or a bath will remove them from your body. Putting clothes in a washing machine will remove bed bugs. Soap and water will kill them.
5. For items that you cannot treat with water or heat, personal items can be placed in a garbage bag and sealed. The bed bugs are then not able to spread from the infested items.

LEARNING CONCEPT:

- Technology

GRADE LEVEL: 3-5

SUBJECT: Health, Science

SETTING: Indoors; classroom with desks or tables

TIME NEEDED: 30-45 minutes

ENTOMOLOGY SKILL: Deciding what can be done to remove bed bugs from student's belongings

LIFE SKILL: Decision making—what can be done to eliminate bed bugs

SUNSHINE STATE

STANDARDS:

HE.3.C.1.1, HE.3.C.1.3, HE.3.C.2.4, HE.3.B.3.3, HE.3.P.1.1, HE.3.P.2.1, HE.4.C.1.1, HE.C.1.3, HE.B.3.3, HE.4.P.1.2, HE.4.P.1.3, HE.5.B.3.3, HE.5.C.1.1, HE.5.C.1.3, HE.5.C.1.5, HE.5.C.2.4, HE.5.P.1.2, HE.5.P.1.2

MATERIALS NEEDED:

Two sets of cards - one set of the student's belongings and the other of household items

TEACHER REVIEW:

Section 1.12
Section 1.13
Section 1.14

Let's Do:

Look at the different types of personal items and match them with household objects that would remove bed bugs from each personal item

Advance preparation: Two sets of cards: one set of the pictures of a student's personal belongings and the other a stack of pictures of household objects. It is helpful if the stacks are copied on different colored paper.

Divide the class into groups of 2, 3, or 4 students.

Give each group two sets of cards (5 bed bug control cards; 15 personal item cards). Place all the cards face down on a table or floor in front of the group.

Explain that some household objects can be used to remove bed bugs from personal belongings. Match each personal belonging to the right household object for removing bed bugs.

The answers are:

Student: Bathtub

Backpack: Dryer

Jacket, hat, shirt, pants, sheets, pillows, stuffed animals: Dryer

Shoes, books, computer, toys: Garbage bag

Chair, bed: Vacuum cleaner

List of cards:

Household objects: freezer/refrigerator, dryer, vacuum cleaner, bathtub, garbage bag

Personal belongings cards: student, backpack, hat, shirt, pants, shoes, books, toys, stuffed animals, computer, pillows, sheets, jacket, chair, bed

Rules of the game

Each student will take a turn. A turn will be to flip over 2 cards. If the student flips over two cards that match a personal belonging with a household object to efficiently remove bed bugs, the student keeps the personal belonging card and replaces the household object card face down on the table or floor. The next student can then turn over another 2 cards.

The game is over when all 15 personal belongings are matched with the appropriate household object to remove bed bugs. The student with the most personal belongings at the end of the game wins.

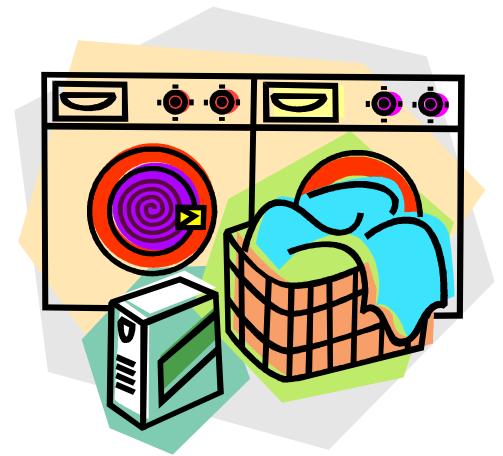

Let's Reflect:

Why is it good to use a dryer get rid of bed bugs on clothing?

Bed bugs can't live past 120° F so a dryer will kill any bed bugs present.

Where, besides beds and chairs, would you use a vacuum cleaner to pick up bed bugs?

Couches, carpets, baseboards, pictures, etc.

What stage of bed bug is not picked up by a vacuum?

The eggs.

If you have some bed bugs on you, what happens to them when you take a bath or shower?

They are washed away.

Let's Apply:

Why would you put your computer in a garbage bag?

How would you protect your backpack from crawling bed bugs in your school?

What other pests might you try to get rid of by sealing your belongings in a garbage bag?

Lice

How will you start acting differently as a result of what you have just learned?

Notes:





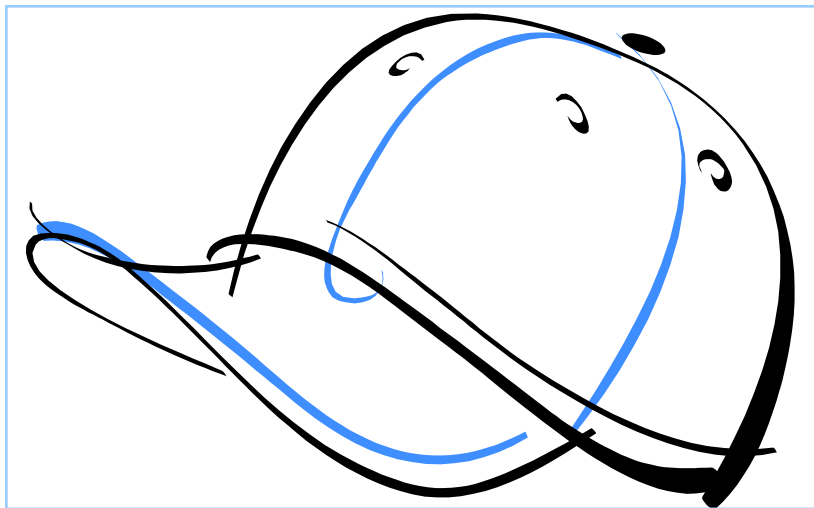

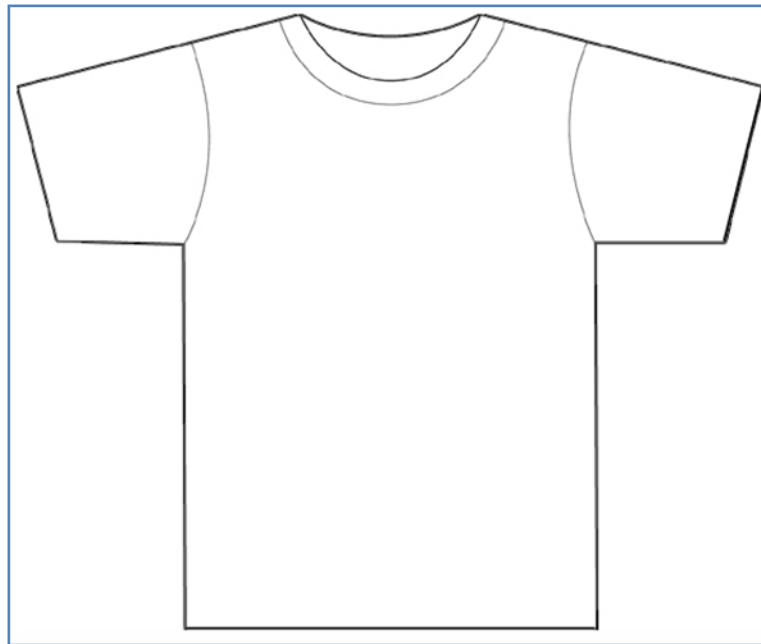



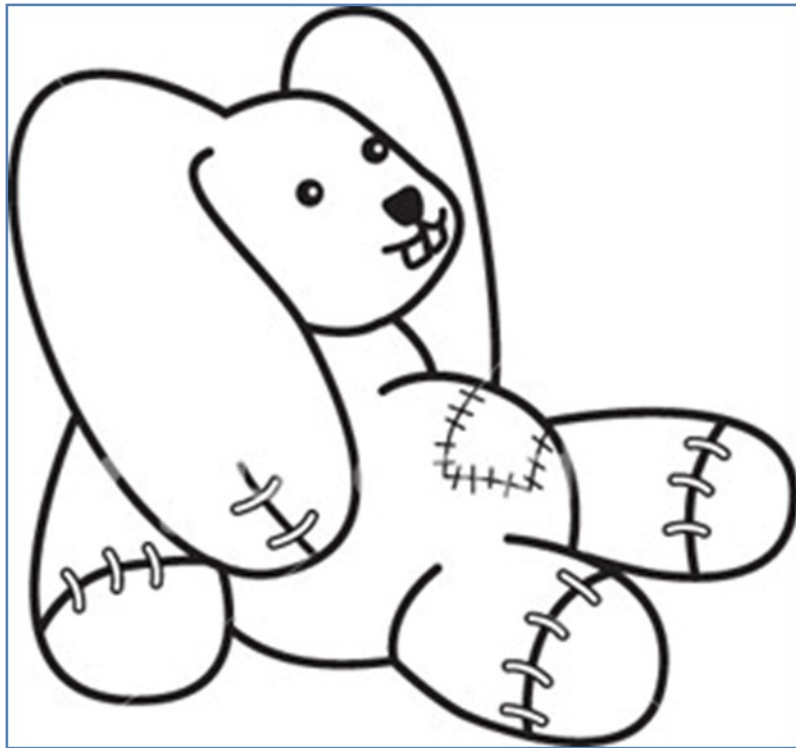

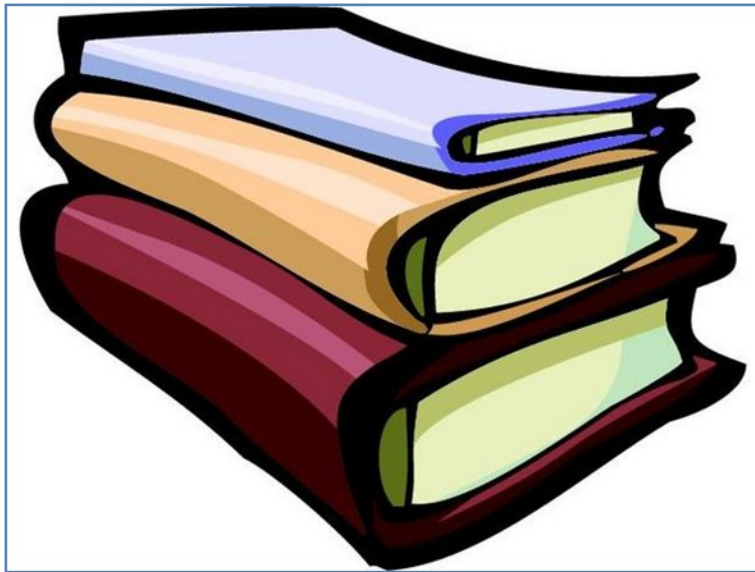

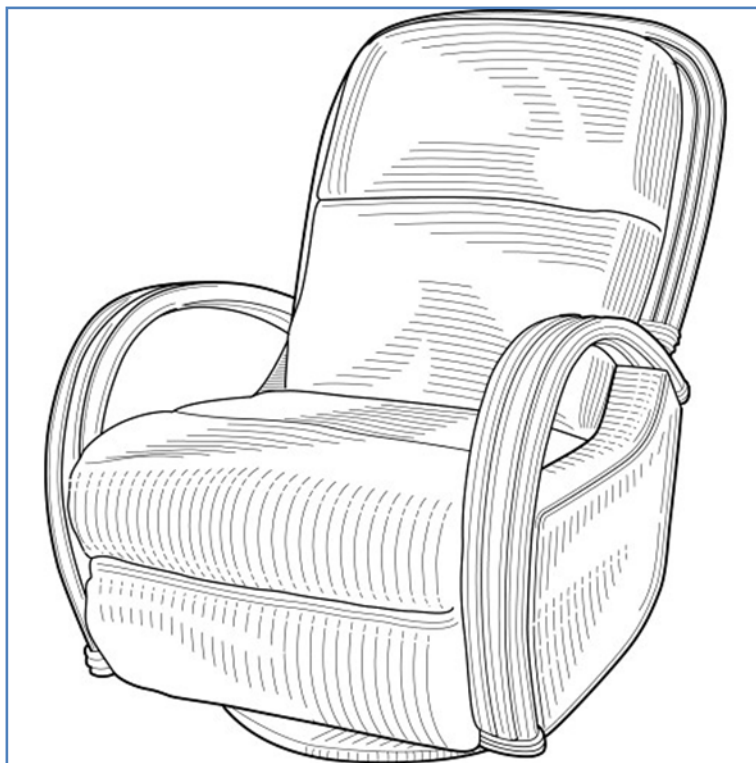

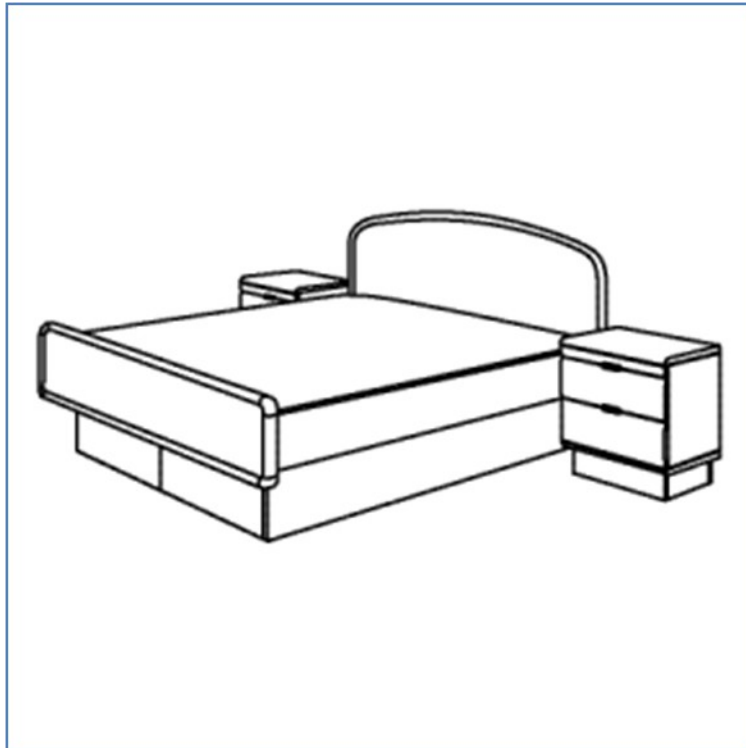



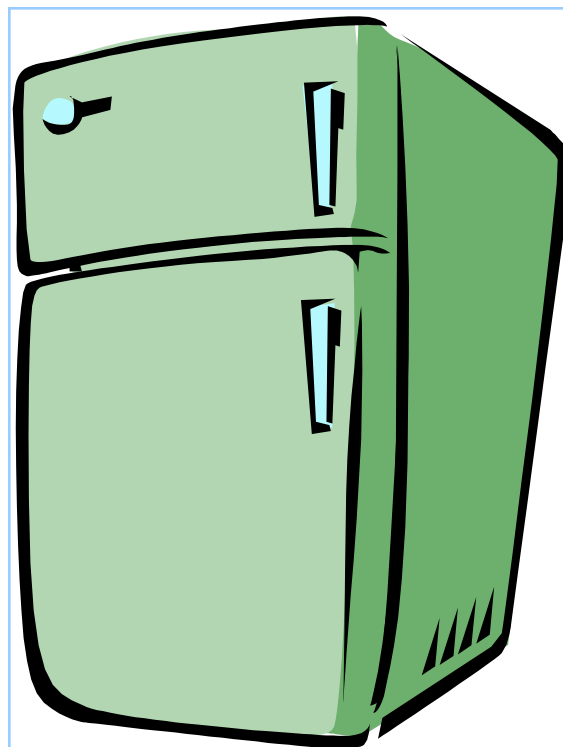

Next Generation Sunshine State Standards and Benchmarks

3rd Grade

	Lesson 1	Lesson 2	Lesson 3
HEALTH LITERACY: BEHAVIOR			
STANDARD 1: Demonstrate the ability to access valid health information, products, and services to enhance health.			
HE.3.B.1.1: Locate resources from home, school, and community that provide valid health			3.5
HE.3.B.1.2: Describe how the media influences the selection of health information, products, and services.			
HE.3.B.1.3: Describe criteria for selecting health information, resources, products, and services.			
HE.3.B.1.4: Identify a variety of technologies to gather health information.			3.5
STANDARD 2: Demonstrate the ability to use interpersonal communication skills to enhance health and avoid or reduce health risks.			
HE.3.B.2.1: Identify effective verbal and nonverbal communication skills to enhance health.			3.3
HE.3.B.2.2: Demonstrate refusal skills that avoid or reduce health risks.			
HE.3.B.2.3: Demonstrate nonviolent strategies to manage or resolve conflict.			
HE.3.B.2.4: Explain ways to ask for assistance to enhance personal health.			3.4
STANDARD 3: Demonstrate the ability to use decision – making skills to enhance health.			
HE.3.B.3.1: Recognize circumstances that can help or hinder health decision making.			3.1
HE.3.B.3.2: Explain when assistance is needed when making a health-related decision.			3.4
HE.3.B.3.3: List healthy options to health-related issues or problems.			3.6
HE.3.B.3.4: Discuss the potential short-term personal impact of each option when making a health-related decision.			
HE.3.B.3.5: Find a health option when making a decision for yourself.			
HE.3.B.3.6: Describe the outcomes of a health-related decision.			
STANDARD 4: Demonstrate the ability to use goal-setting skills to enhance health.			
HE.3.B.4.1: Select a personal health goal and track progress toward achievement.			3.4
HE.3.B.4.2: Examine resources that could assist in achieving a small group personal health goal.			

Next Generation Sunshine State Standards and Benchmarks

APPENDIX A

3rd Grade

	Lesson 1	Lesson 2	Lesson 3
HEALTH LITERACY:CONCEPTS			
STANDARD 1: Comprehend concepts related to health promotion and disease prevention to enhance health.			
HE.3.C.1.1: Describe health behaviors that affect personal health.			3.6
HE.3.C.1.2: Identify that there are multiple dimensions of health.			3.3
HE.3.C.1.3: Describe ways a safe, healthy classroom can promote personal health	1.2		3.6
HE.3.C.1.4: Describe common childhood health conditions			
HE.3.C.1.5 : Describe why it is important to seek health care.			
HE.3.C.1.6: Recognize that body parts and organs work together to form human body systems.			
STANDARD 2: Analyze the influence of family, peers, culture, media, technology, and other factors on health behaviors.			
HE.3.C.2.1: Explore how different family traditions and customs may influence health		2.1	3.2
HE.3.C.2.2: Explore how friends’ various traditions and customs may influence health behaviors.		2.1	3.2
HE.3.C.2.3: Explore how the traditions and customs of the school and community influence health behavior of children.			3.2
HE.3.C.2.4: Identify classroom and school rules that promote health and disease			3.6
HE.3.C.2.5: Discuss the positive and negative impacts media may have on health.			3.5
HE.3.C.2.6: Discuss the positive and negative impacts technology may have on health.			3.5
HE.3.C.2.7: Discuss how the community can influence healthy and unhealthy behaviors.			3.3

Next Generation Sunshine State Standards and Benchmarks

APPENDIX A

3rd Grade

	Lesson 1	Lesson 2	Lesson 3
HEALTH LITERACY: PROMOTIONS			
STANDARD 1: Demonstrate the ability to practice advocacy, health-enhancing behavior, and avoidance or reduction of health risks for oneself.			
HE.3.P.1.1: Practice responsible personal health behaviors.			3.1 3.6
HE.3.P.1.2: Investigate a variety of behaviors that avoid or reduce health risks.	1.1	2.2	3.4 3.6
STANDARD 2: Demonstrate the ability to advocate for individual, peer, school, family, and community health.			
HE.3.P.2.1: Suggest others make positive health choices.			3.1 3.2

Next Generation Sunshine State Standards and Benchmarks

4th Grade

	Lesson 1	Lesson 2	Lesson 3
HEALTH LITERACY: BEHAVIOR			
STANDARD 1: Demonstrate the ability to access valid health information, products, and services to enhance health.			
HE.4.B.1.1: Describe characteristics of valid health information, products and services.		2.2	3.5
HE.4.B.1.2: Examine resources from home, school, and community that provide valid health information.			
HE.4.B.1.3: Construct criteria for selecting health resources, products and services.			
HE.4.B.1.4: Compare a variety of technologies to gather health information.			3.5
STANDARD 2: Demonstrate the ability to use interpersonal communication skills to enhance health and avoid or reduce health risks.			
HE.4.B.2.1: Explain effective verbal and nonverbal communication skills to enhance health.			3.3
HE.4.B.2.2: Identify refusal skills and negotiation skills that avoid or reduce health risks.			
HE.4.B.2.3: Discuss nonviolent strategies to manage or resolve conflict.			
HE.4.B.2.4: Demonstrate ways to ask for assistance to enhance personal health.			3.4
STANDARD 3: Demonstrate the ability to use decision – making skills to enhance health.			
HE.4.B.3.1: Identify circumstances that can help or hinder health decision-making.		2.1	
HE.4.B.3.2: Examine when assistance is needed to make a health-related decision.			3.4
HE.4.B.3.3: Itemize health options to health-related issues or problems.			3.6
HE.4.B.3.4: Predict the potential short-term impact of each option on self and others when making a health-related decision.			
HE.4.B.3.5: Choose a health option when making decisions for yourself and/or others.			
HE.4.B.3.6: Examine the outcomes of a health-related decision.			
STANDARD 4: Demonstrate the ability to use goal-setting skills to enhance health.			
HE.4.B.4.1: Create a personal health goal and track progress toward achievement.			3.4
HE.4.B.4.2: Categorize resources that could assist in achieving a small group personal health goal.			

Next Generation Sunshine State Standards and Benchmarks

4th Grade

	Lesson 1	Lesson 2	Lesson 3
HEALTH LITERACY: CONCEPTS			
STANDARD 1: Comprehend concepts related to health promotion and disease prevention to enhance health.			
HE.4.C.1.1: Identify the relationship between healthy behaviors and personal health.	1.1		3.6
HE.4.C.1.2: Identify examples of mental/emotional, physical, and social health			3.3
HE.4.C.1.3: Describe ways a safe, healthy classroom can promote personal health		2.2	3.4 3.6
HE.4.C.1.4: Describe ways to prevent common childhood injuries and health problems.	1.2		3.6
HE.4.C.1.5 : Distinguish difference among various health-care providers, products, and services.			
HE.4.C.1.6: Identify the human body parts and organs that work together to form healthy body systems.			
STANDARD 2: Analyze the influence of family, peers, culture, media, technology, and other factors on health behaviors.			
HE.4.C.2.1: Explain the importance of family on health practices and behaviors.		2.1	3.4 3.6
HE.4.C.2.2: Explain the important role that friends/peers may play on health practices and behaviors.		2.2	3.3
HE.4.C.2.3: Explain the important roles that school and community play on health practices and behaviors.			3.3
HE.4.C.2.4: Identify classroom and school rules that promote health and disease.			3.6
HE.4.C.2.5: Explain how media influences personal thoughts, feelings, and health behaviors.			3.5
HE.4.C.2.6: Explain how technology influences personal thoughts, feelings, and health behaviors.			3.5

Next Generation Sunshine State Standards and Benchmarks

APPENDIX A

4th Grade

	Lesson 1	Lesson 2	Lesson 3
HEALTH LITERACY: PROMOTIONS			
STANDARD 1: Demonstrate the ability to practice advocacy, health-enhancing behavior, and avoidance or reduction of health risks for oneself.			
HE.4.P.1.1: Illustrate responsible personal health behaviors.			3.2 3.4
HE.4.P.1.2: Illustrate a variety of healthy practices and behaviors to maintain or improve personal health.	1.1		3.1 3.6
HE.4.P.1.3: Illustrate a variety of behaviors that avoid or reduce health risks.		2.2	3.4 3.6
STANDARD 2: Demonstrate the ability to advocate for individual, peer, school, family, and community health.			
HE.4.P.2.1: Assist others to make positive health choices.			3.1 3.2

Next Generation Sunshine State Standards and Benchmarks

5th Grade

	Lesson 1	Lesson 2	Lesson 3
HEALTH LITERACY: BEHAVIOR			
STANDARD 1: Demonstrate the ability to access valid health information, products, and services to enhance health.			
HE.5.B.1.1: Discuss characteristics of valid health information, products, and services.			3.5
HE.5.B.1.2: Compile resources from home, school, and community that provide health information.			
HE.5.B.1.3: Evaluate criteria for selecting health resources, products, and services.			3.5
HE.5.B.1.4: Demonstrate the use of a variety of technologies to gather health information.			3.5
STANDARD 2: Demonstrate the ability to use interpersonal communication skills to enhance health and avoid or reduce health risks.			
HE.5.B.2.1: Illustrate techniques of effective verbal and nonverbal communication skills to enhance health.			3.3
HE.5.B.2.2: Discuss refusal skills and negotiation skills that avoid or reduce health risks.			
HE.5.B.2.3: Illustrate effective conflict resolution strategies.			
HE.5.B.2.4: Determine ways to ask for assistance to enhance the health of self and others.			3.4
STANDARD 3: Demonstrate the ability to use decision – making skills to enhance health.			
HE.5.B.3.1: Describe circumstances that can help or hinder health decision making.			3.1
HE.5.B.3.2: Analyze when assistance is needed when making a health-related decision.			3.4
HE.5.B.3.3: Summarize healthy options to health-related issues or problems.			3.6
HE.5.B.3.4: Compare the potential short-term impact of each option on self and others when making a health-related decision.			
HE.5.B.3.5: Select a health option when making decisions for yourself and/or others.			
HE.5.B.3.6: Analyze the outcomes of a health-related decision.			
STANDARD 4: Demonstrate the ability to use goal-setting skills to enhance health.			
HE.5.B.4.1: Specify a personal health goal and track progress toward achievement.			3.4
HE.5.B.4.2: Select reliable resources that would assist in achieving a small group personal health goal.			

Next Generation Sunshine State Standards and Benchmarks

5th Grade

	Lesson 1	Lesson 2	Lesson 3
HEALTH LITERACY: CONCEPTS			
STANDARD 1: Comprehend concepts related to health promotion and disease prevention to enhance health.			
HE.5.C.1.1: Describe the relationship between healthy behaviors and personal health.	1.1		3.6
HE.5.C.1.2: Explain the physical, mental/emotional, social, and intellectual dimensions of health.			3.3
HE.5.C.1.3: Explain ways a safe, healthy home environment and school environment promote personal health.			3.6
HE.5.C.1.4: Compare ways to prevent common childhood injuries and health problems.	1.2		
HE.5.C.1.5 : Recognize how appropriate health care can promote personal health.			3.6
HE.5.C.1.6: Explain how human body parts and organs work together in health body systems, including the endocrine and reproductive systems.			
STANDARD 2: Analyze the influence of family, peers, culture, media, technology, and other factors on health behaviors.			
HE.5.C.2.1: Predict how families may influence various health practices of children.		2.1	3.2
HE.5.C.2.2: Predict how friends/peers may influence various health practices of children.		2.1	3.3
HE.5.C.2.3: Predict how the school and community influence various health promotion and disease prevention.			3.3
HE.5.C.2.4: Give examples of school and public health policies that influence health			3.6
HE.5.C.2.5: Determine how media influences family health behavior and the selection of health information, products, and services.			3.5
HE.5.C.2.6: Describe ways that technology can influence family health behaviors.			3.5
HE.5.C.2.7: Discuss how various cultures can influence personal health beliefs.		2.1	
HE.5.C.2.8: Investigate influences that change health and behavior.			

Next Generation Sunshine State Standards and Benchmarks

APPENDIX A

5th Grade

	Lesson 1	Lesson 2	Lesson 3
HEALTH LITERACY: PROMOTIONS			
STANDARD 1: Demonstrate the ability to practice advocacy, health-enhancing behavior, and avoidance or reduction of health risks for oneself.			
HE.5.P.1.1: Model responsible personal health behavior.			
HE.5.P.1.2: Apply a variety of healthy practices and behaviors to maintain or improve personal health.			3.1 3.6
HE.5.P.1.3: Demonstrate a variety of behaviors that avoid or reduce health risks	1.1	2.2	3.4 3.6
STANDARD 2: Demonstrate the ability to advocate for individual, peer, school, family, and community health.			
HE.5.P.2.1: Persuade others to make positive health choices.		2.2	3.2

Teacher Feedback Form

1. If you are a teacher, what grade do you teach?
2. Approximately how many students have received lessons from this workbook?
3. How did you find out about this activity book?
4. Which lessons or activities did you complete?
5. Do you have suggestions for additional activities, web links, or resources that we might include in a revised activity book?
6. Comments:

Please send, fax, or email your completed form to:

Erin Harlow, Duval County Extension Office
University of Florida/Institute of Food and Agricultural Sciences
1010 N McDuff Ave.
Jacksonville, FL 32254
Phone: 904-387-8850
Fax: 904-387-8902
erine@coj.net